

Audionet

PREI G3

Stereo Pre-Amplifier

User's Manual

Contents

1	Preface.....	5
1.1	Included.....	6
1.2	Transport.....	6
2	Overview front panel	7
3	Overview back panel	8
4	Installation and power supply	9
4.1	Placement	9
4.2	Mains connection.....	9
4.3	Orientation of mains plug.....	10
4.4	Additional earth connection	10
5	Inputs and outputs.....	11
5.1	Inputs.....	11
5.2	Outputs	11
5.3	Recording devices	12
5.4	Monitor.....	12
5.5	Phono	12
5.6	Audionet Link.....	13
5.7	External power supply EPS or EPX	13
5.8	Trigger output.....	14
6	Usage	15
6.1	Powering up	15
6.2	Switching on and off.....	15
6.3	Mains phase detection	16
6.4	Using Audionet Link	16
6.5	Control elements on the front panel	17
6.6	Volume control.....	17
6.7	Display	18
6.8	Input selection.....	19
6.9	Muting	20
7	Setup menu	21

7.1	Set Monitor	22
7.2	Set Headphones.....	23
7.3	Set Dim Level.....	24
7.4	Balance Adjust.....	25
7.5	Offset Adjust.....	26
7.6	Set DC Servo	27
7.7	Channel name	28
7.8	Set Out 2 (Sub).....	29
7.9	Set Autostart	30
7.10	Set Channel for By-Pass Mode.....	30
7.11	Set DC Servo for By-Pass M.....	33
7.12	Overview factory defaults	34
8	Audionet Metal Remote Control.....	35
8.1	Key assignment PRE1 G3	36
8.2	Changing the batteries	36
8.3	Settings for Audionet preamplifier	37
9	Technical information	39
9.1	Design	39
9.2	Power supply.....	39
9.3	Circuitry	39
9.4	Handling.....	39
10	Security advice	40
11	Technical data	41

1 Preface

The Audionet Team congratulates you on your purchase of this unit.

But before you start listening to your new Audionet PRE1 G3, please read this manual carefully so you are able to use and enjoy all functions of this unit without drawback on music quality.

1.1 Included

Included you will find the following items:

- the stereo pre-amplifier PRE1 G3
- the user's manual (that you are currently reading)
- one standard mains cord
- one green-yellow cord for an additional earth connection
- Audionet Metal Remote Control *RC 1*

1.2 Transport



Important

- Please transport the PRE1 G3 only in the included package.
- Always use the provided bag to prevent scratches on the casing.
- Please allow the PRE1 G3 to adapt to the climatic conditions in your listening room before you switch on the unit for the first time after transport.

2 Overview front panel

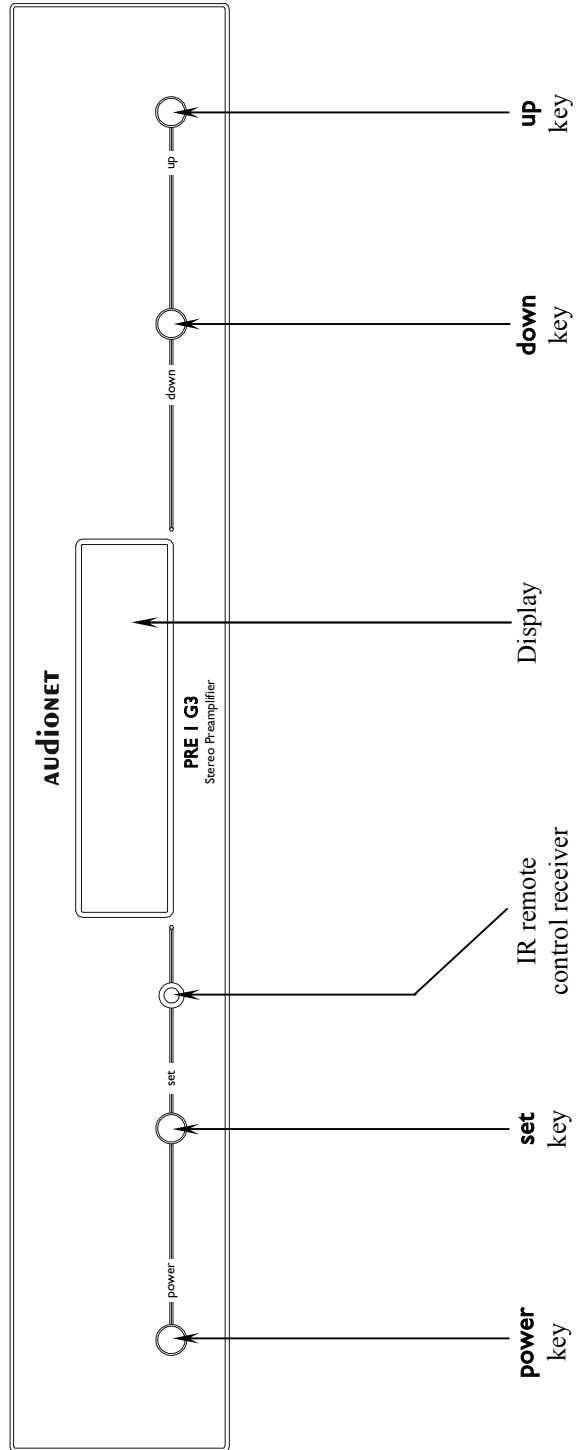

3 Overview back panel

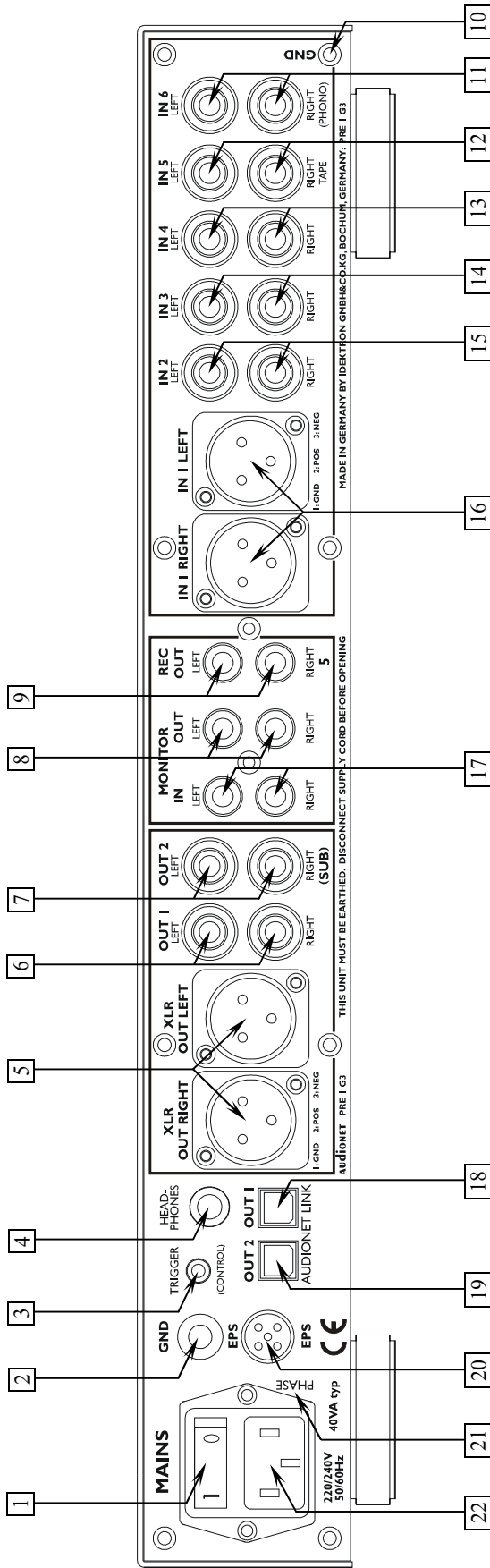

4 Installation and power supply



Important

- During connecting and removing of sources or amplifiers to the PRE1 G3 all units of your audio system have to be switched off to prevent damage of the PRE1 G3 or any of the other connected units.
- Please make sure that all cables are in absolute best conditions! Broken shields or short-cut cables could damage the PRE1 G3 and/or any other connected unit.

4.1 Placement



Important

- It is recommended to place the PRE1 G3 into a high quality rack or onto a stable table.
- Do not expose the unit to direct sunlight.
- Do not cover the ventilation slots.
- Do not place the PRE1 G3 in close range to heat sources like radiators.
- Do not place the PRE1 on top of other units, especially not on top of power amplifiers, pre amplifiers or similar that produce heat. Both units could suffer damage from thermal overload.
- Do not use the unit in places where it is exposed to vibrations.
- Do not place the unit close to loudspeakers or into the corner of a room where it is exposed to high levels of sonic energy, which might reduce the sound quality of the unit.

4.2 Mains connection

The mains input 21* is on the back panel of the PRE1 G3. To connect the unit to mains use the included mains cord. If you prefer to use a different power cord make sure that it meets the specifications for your home country.



Important

- The electrical specifications of your home country must meet the electrical specifications printed onto the back panel.

* see numbers in section 'Overview back panel' on page 8.

- The PRE1 G3 is a Class I unit and must be earthed. Please ensure a stable earth connection. Phase ('hot' pin) is marked on the back panel ('phase') [21].
- If you connect the mains cord please make sure that mains switch [1] at the back panel is switched off.
- Never pull the mains plug while the PRE1 G3 is switched on! Before you pull the mains cord off its socket [22] at the back panel, power down the unit to stand-by mode and switch off the unit using mains switch [1].

Only in cases of extended absence – like vacations – or if massive trouble on the mains power is to be expected you should switch off the PRE1 G3 from the mains using mains switch [1]. To disconnect the unit completely from mains pull the mains plug.



Tip

- The use of high quality mains cords could improve sound quality. Ask your local dealer for more information.

4.3 Orientation of mains plug

The correct polarization of mains is important for reasons of audio clarity and stability. Please connect the mains cord so that the hot pin of the wall outlet is connected to the pin of the mains input [22] marked 'phase' [21]. Your Audionet PRE1 G3 is able to detect a wrong polarization of the mains plug during start-up. If the message

**Attention: Mains
Phase incorrect!**

appears in the display, switch off the unit and flip the mains plug in the wall outlet (see section '*Mains phase detection*' on page 16).

4.4 Additional earth connection

Included with the PRE1 G3 you will find a green-yellow cord for the additional earth connection. Attach this cord to the earth connector [2] on the back panel of the PRE1 G3 and put the plug into the mains socket right beside the mains cord of your PRE1 G3. This ensures an additional and stable earth connection resulting in a better sound.



Note

- We strongly recommend using the additional earth connection!
- Also, a stable earth connection is necessary for the PRE1 G3 detecting the polarization of mains phase correctly.

5 Inputs and outputs



Important

- During connecting and removing of sources or amplifiers to the PRE1 G3 all units of your audio system have to be switched off to prevent damage of the PRE1 G3 or any of the other connected units.
- Please make sure that all cables are in absolute best conditions! Broken shields or short-cut cables could damage the PRE1 G3 and/or any other connected unit.

5.1 Inputs

The PRE1 G3 is equipped with 5 Cinch inputs [11] to [15] and one balanced (XLR) input [16] for connecting signal sources at line level. Additionally, the monitor input [17] can be used as another line level input.

Please connect the left and right input of the same number printed on the back panel of the PRE1 G3 to the corresponding output of the source you would like to connect to the PRE1 G3.

5.2 Outputs

The PRE1 G3 is equipped with two Cinch outputs **OUT 1** [6] and **OUT 2** [7] as well as one balanced (XLR) output **XLR OUT LEFT** and **XLR OUT RIGHT** [5] for the left and right channel to connect the unit to your amplifier(s).

Use the Cinch output **OUT 1** [6] to connect the PRE1 G3 to your power amplifier(s) using high quality Cinch cables. Alternatively, you may connect the power amplifier using the balanced (XLR) outputs **XLR OUT LEFT** and **XLR OUT RIGHT** [5] in case your power amplifier does not support Cinch (line) inputs.



Note

- Of course you may use the Cinch output **OUT 2** [7] to connect the unit to your amplifier(s). The menu item **SET SUB OUT** has to be set to **Left & Right**, otherwise the Cinch output **OUT 2** [7] works as a Subwoofer output (see section 'Set Out' on page 29).



Tip

- The pinning of the balanced (XLR) input **16** and output **5** is printed right beside the connectors.

5.3 Recording devices

You can connect up to two recording devices or effect processors to the PRE1 G3 for recording and playback.

Connect the recording devices (like DAT or tape recorder) to the recording output **REC OUT 9** of the PRE1 G3. For playback please connect your recording devices only to input no. 5 **IN 5 12** of the PRE1 G3. If they are also connected to the output **REC OUT 9** of your PRE1 G3. If you select input no. 5 **IN 5 12** the output **REC OUT 9** is switched off to prevent any feedback loops between your recording device and the PRE1 G3.

Please use inputs no. 1 **16** to no. 4 **13** and no. 6 **11** to connect sources you like to record from. With these inputs the recording output **REC OUT 9** is always active

5.4 Monitor

The monitor loop of the PRE1 G3 makes it possible to insert a recording device (for read after write verify) or an effects processor (e.g. surround decoders) into the signal path.

Connect monitor output **MONITOR OUT 8** of the PRE1 G3 to the input of the unit you would like to insert. Also, connect the output of the unit to the monitor input **MONITOR IN 17** of the PRE1 G3.

For further information on how to use the monitor loop please refer to section '*Set Monitor*' on page 22.

5.5 Phono

The PRE1 G3 can be upgraded with a phono pre amplifier. In this case use input no. 6 **IN 6 11** marked **PHONO** to connect your turn table to the PRE1 G3. Connect the earth wire of your turn table to the earth connector **GND 2** right beside input no. 6. For further information on the optional phono module please refer to its user's manual.



Important

- If the PRE1 G3 is upgraded with the optional phono module, input no. 6 **IN 6** [11] must only be used to connect a turn table.

5.6 Audionet Link

For your convenience, the PRE1 G3 can switch on/off all other Audionet units (e.g. power amplifiers) connected via 'Audionet Link' by a simple touch on the remote control or the **power** key on the front panel.

You only need a simple optical 'Toslink' cable. Connect the 'Audionet Link' output **OUT 1** [18] or **OUT 2** [19] of your PRE1 G3 to the 'Audionet Link' input of unit to be controlled.

The PRE1 G3 is equipped with two 'Audionet Link' outputs **OUT 1** [18] and **OUT 2** [19]. 'Audionet Link' output 1 **OUT 1** [18] is always on while the PRE1 G3 is switched on. However, 'Audionet Link' output **OUT 2** [19] is controlled depending on the settings for the headphones output. Please refer to section '*Set Headphones*' on page 23.

Therefore, use 'Audionet Link' output **OUT 2** [19] in order to connect power amplifiers to the PRE1 G3 via 'Audionet Link'. Connect units you would like to control independently from the headphones settings (e.g. tuner, CD player etc) to 'Audionet Link' output **OUT 1** [18].



Tip

- Audionet source units and power amplifiers are usually equipped not only with an 'Audionet Link' input, but additionally with an 'Audionet Link' output to connect further Audionet devices to be controlled via 'Audionet Link' in a daisy chain. Connect this 'Audionet Link' output to the 'Audionet Link' input of the next Audionet unit using a simple optical 'Toslink' cable allowing you to switch on/off your complete Audionet system by your Audionet pre amplifier.

5.7 External power supply EPS or EPX

In order to use one of the optional external precision power supplies Audionet EPS or Audionet EPX with you PRE1 G3 please proceed as follows:

1. **Make sure both PRE1 G3 and EPS / EPX are switched off and disconnected from mains.**
2. **Connect the EPS / EPX with the included cable to input jack EPS [20] on the back panel of the PRE1 G3. The shape of the plug prevents any wrong polarity. The small 'nose' inside the plug has**

to face upwards. Now screw the ring of the plug onto the EPS input jack **20**.

3. Connect **both** (!!) units (PRE1 G3 **and** EPS / EPX) to mains.
4. First, switch on the EPS / EPX on its back panel. Then switch on the PRE1 G3 with the mains switch **1**.
5. Use the **power** key on the front panel or the key **PRE** of the Audionet Metal Remote Control *RC 1* or *RC 2* to switch on the PRE1 G3. The PRE1 G3 is now ready to use and gets its power from the external power supply EPS / EPX.
6. To switch off the PRE1 G3 into stand-by mode, use the **power** key on the front panel or key **PRE** of the Audionet Metal Remote Control *RC 1* or *RC 2*.



Important

- Never switch on or off the EPS / EPX on its back panel while the PRE1 G3 is operating.
- For further information referring to the external power supply EPS / EPX please consult its user's manual.



Tip

- Use a high quality cable (for example the Audionet APC) to connect the EPS / EPX to mains. The sound will improve.

5.8 Trigger output

Use trigger output **TRIGGER 3** to control (e.g. switch on/off) non-Audionet devices. If you switch on the PRE1 G3 from stand-by mode, the trigger output **3** provides a signal of 12 Volts DC. If you power down the unit to stand-by mode, the signal of the trigger output **3** will be 0 Volts.



Tip

- Use a 3.5 mm telephone mono plug to connect a device to the trigger output **3** of your PRE1 G3. The pinning is as follows:

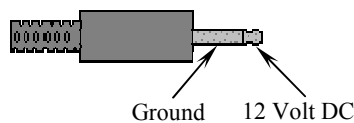



6 Usage

All functions of the PRE1 G3 are microprocessor controlled. This guarantees highest precision, exclusive functions, easy handling and protection against operating errors.

6.1 Powering up

First of all, please make sure your PRE1 G3 is connected correctly to your signal sources, power amplifier(s) and mains (see section '*Installation and power supply*' on page 9 and '*Inputs and outputs*' on page 11).

The PRE1 G3 is a stand-by unit. Please operate the mains switch  on the back panel. The display shows a welcome message for a brief moment. After that the PRE1 G3 is in stand-by mode.

Only in cases of extended absence (like vacations) or if massive trouble on the mains power is to be expected (e.g. thunder storms) it is recommended to disconnect the PRE1 G3 from the mains. While the PRE1 G3 is in stand-by mode, operate mains switch  on the back panel. The display will go dark. To disconnect the PRE1 G3 from mains completely, you have to pull the mains cord off the mains jack .



Important

- **Before you switch off the PRE1 G3 from mains, power down and discharge completely all units connected to the outputs of the PRE1 G3.**

6.2 Switching on and off

To power up the PRE1 G3 from stand-by mode, press the **power** key on the front panel. The PRE1 G3 issues the message **Waking up...** In case the mains plug has the incorrect polarization a warning will appear in the display (see section '*Mains phase detection*' on page 16). After that the unit is in normal operating mode and ready to use.

If you would like to switch off the unit, please press the **power** key on the front panel. The display shows the message **Going to sleep..** and unit enters the stand-by mode.



Note

- Of course, you may switch on/off the PRE1 G3 with the Audionet Metal Remote Control *RC 1* or *RC 2*. For detailed information please refer to section '*Audionet Metal Remote Control*' on page 35.

6.3 Mains phase detection

The correct polarization of mains is important for reasons of audio clarity and stability. Please connect the mains cord that the 'hot' pin of the wall outlet is connected to the pin marked **'phase'** 21 of the mains input 22 on the back panel. The PRE1 G3 recognizes the incorrect polarization of the mains plug automatically. Right after switching on the unit from stand-by mode by pressing the **power** key on the front panel the following message will appear in the display in case the mains polarization is incorrect:

**Attention: Mains
Phase incorrect!**

If you read the above message, switch off the unit by pressing the **power** key. Please wait until the display no longer reads **Going to sleep...** Disconnect the PRE1 G3 from mains by operating the mains switch 1. Now pull the mains plug and re-insert it into the mains socket rotated by 180°.

If you switch on the unit again, the warning should not appear now.



Important

- If the PRE1 G3 issues the mains polarization warning or no warning at all for both positions of the mains plug, check the connection to earth of your mains socket and mains cord. **You have to ensure a stable connection to earth for the mains phase detection of the PRE1 G3 to work correctly!**

6.4 Using Audionet Link

Your PRE1 G3 is equipped with two 'Audionet Link' outputs **OUT 1** 18 and **OUT 2** 19 allowing you to switch on/off further Audionet units (e.g. power amplifiers, CD player or tuner) connected via 'Audionet Link' (also see section '*Audionet Link*' on page 13).

If the rest of your Audionet system is connected to your PRE1 G3 via 'Audionet Link', all linked units will be automatically switched on /off as soon as you switch on/off your PRE1 G3 using the **power** key on the front panel or the Audionet Metal Remote Control *RC 1* or *RC 2*.



Note

- The 'switch on/off' signal of the 'Audionet Link' output **OUT 2** 19 is issued depending on the headphones settings (see section '*Set Headphones*' on page 23).
- Please read section '*Audionet Link*' on page 13. Also, consult the user's manual of your Audionet components connected via 'Audionet Link' for further information.

6.5 Control elements on the front panel

The front panel has four keys to control the PRE1 G3 (see section '*Overview front panel*' on page 7). With these keys you can control all functions as well as all setup options to adjust the unit to your preferences (see section '*Setup menu*' on page 21).

power	Use key to switch on/off the unit (see section ' <i>Switching on and off</i> ' on page 15).
set	Push key shortly to navigate through the setup menu. Keep key pushed for longer than two seconds to exit the setup menu (see section ' <i>Setup menu</i> ' on page 21).
down	Push key to reduce volume, select previous input channel (see section ' <i>Input selection</i> ' on page 19) or change an option of the setup menu (see section ' <i>Setup menu</i> ' on page 21).
up	Push key to increase volume, select next input channel (see section ' <i>Input selection</i> ' on page 19) or change an option of the setup menu (see section ' <i>Setup menu</i> ' on page 21).

6.6 Volume control

While the PRE1 G3 is in normal operating mode use keys **up** and **down** on the front panel to adjust the volume. **up** increases, **down** decreases the volume.

The volume control of the PRE1 G3 runs in a range from -80 dB to $+6$ dB in real 1 dB steps relatively to the level of the input signal. Differences in input levels can be adjusted for each input channel of the PRE1 G3 separately (see section '*Offset Adjust*' on page 26).



Note

- Use keys **up** and **down** also to change an option from the setup menu (see section '*Setup menu*' on page 21) as well as to select an input channel (see section '*Input selection*' on page 19).

6.7 Display

The display provides in the normal operating mode the following information:

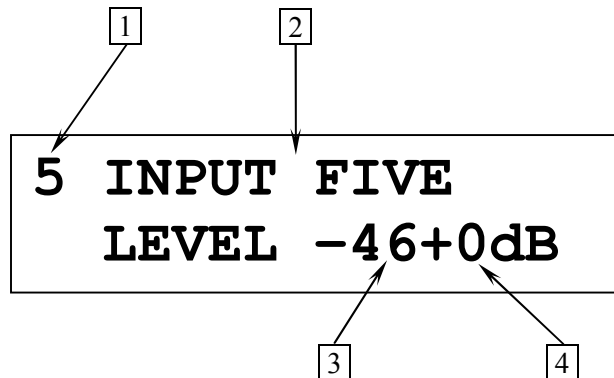

- 1 number of currently selected input channel, corresponds to the number printed above the input jack on the back panel (see section '*Overview back panel*' on page 8).
- 2 name of the currently selected input channel, fully user-definable (see section '*Channel name*' on page 28).
- 3 current volume level in dB relative to the input level (see section '*Volume control*' on page 17).
- 4 offset for input level of currently selected input channel (see section '*Offset Adjust*' on page 26).

As soon as you enter the setup menu by pushing the **set** key, the display changes to show information related to the selected menu item. For further display details refer to the description of each menu item in section '*Setup menu*' starting from page 21.



Note

- After 10 minutes without any user interaction the 'display saver' is invoked automatically. The display then shows only the number of the currently selected input channel and the current volume level. Please refer to section '*Set Dim Level*' on page 24 for further information on the 'display saver' mode.

6.8 Input selection

Push the **set** key on the front panel once for less than two seconds. The display shows:



**SELECT INPUT :
5 INPUT FIVE**

The 2nd line of the display provides the number and the (user-definable) name of the currently selected input channel.

Use keys **up** and **down** select the desired input channel. Push **set** key again (for less than 2 seconds) to actually switch to the selected input channel.

The PRE1 G3 features a 'soft' input selection. During the switching of inputs, first the volume is stepped down to -80 dB, followed by switching off the outputs. Now the input section switches to the new input channel. Afterwards the outputs are switched on again, and finally the volume is stepped up to its original level.



Note

- Leave the input selection function by holding down the **set** key longer than 2 seconds.
- Using the Audionet Metal Remote Control *RC 1* or *RC 2*, select an input channel by using the keys **CH+** and **CH-** to switch to the next or previous input channel without using the **Select Input** function (see section '*Key assignment PRE1 G3*' on page 36).
- If the currently displayed input channel is dedicated to the By-Pass mode, this is indicated by a '*' in the upper right corner of the display:

Input 5 is dedicated to the By-Pass Mode



**SELECT INPUT : *
5 INPUT FIVE**

(see section '*Set Channel for By-Pass Mode*' on page 30).

6.9 Muting



Note

- The muting function is only available through the Audionet Metal Remote Control *RC 1* or *RC 2*.

Press key  of the Audionet Metal Remote Control *RC 1* or *RC 2* to mute or un-mute your PRE1 G3.

Just as well as the input selection, the PRE1 G3 uses 'soft' muting, i.e. volume is stepped down gently to -80 dB, then the outputs are switched off. The display informs the user of a muted unit with the text **MUTE** in the 2nd line. Even if the dim level is set to **Off**, the text is displayed.

To un-mute the PRE1 G3 press key  again. Here as well, the volume is stepped up gently to its original level after switching on the outputs.



Note

- While the unit is muted, you may of course select a different input channel as described above. But the PRE1 G3 will stay muted until you press the key  again to un-mute and restore the original volume level.
- If you turn up the volume by using the key **up** or **VOL+**, while the PRE1 G3 is muted, the muting function will be deactivated and the new volume level set.

7 Setup menu

To adjust the PRE1 G3 to your preferences, please use the setup menu.

Push the **set** key on the front panel longer than two seconds to go to the first item of the setup menu. Navigate to the next menu item, by pushing the **set** shortly (less than two seconds). Below is a list of all menu items of the setup menu.

After the last menu item you will leave the setup menu automatically. Of course, you may leave the setup menu from each menu item by holding the **set** key down for longer than two seconds. The PRE1 G3 will return to the normal operating mode.

The order of items in the setup menu is:

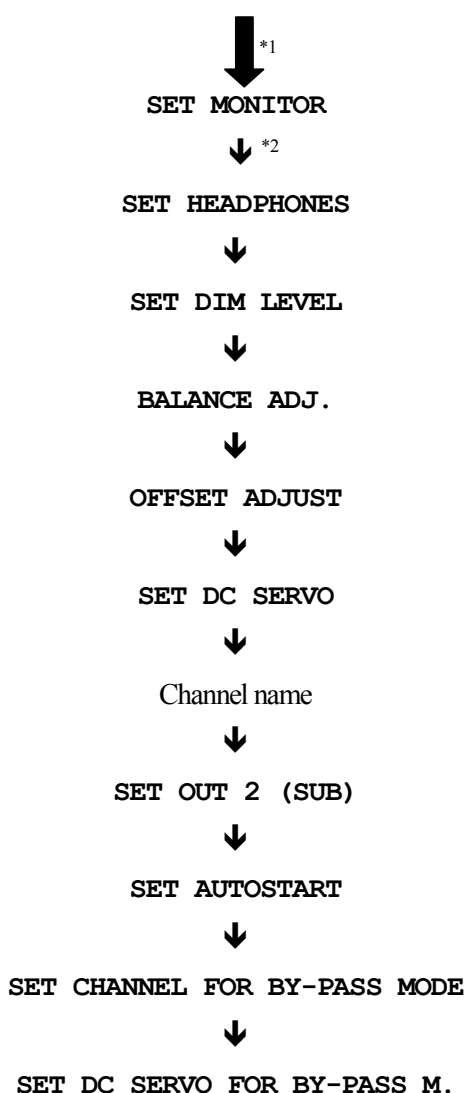

*1 press and hold **set** key for longer than 2 seconds

*2 ↓ = push **set** key for less than 2 seconds

Change any setting of a menu item by using the keys **up** and **down** on the front panel.



Note

- If you make no adjustments for longer than 12 seconds the PRE1 G3 will automatically leave the setup menu and return to normal operating mode.
- While you are in the setup menu the display brightness is set to 100% for better readability. After leaving the setup menu the display brightness is automatically reset to its user selected level.
- If you power down the PRE1 G3 to stand-by mode all settings are stored automatically in the non-volatile memory of the unit. Even after disconnecting from mains the PRE1 G3 will still remember your settings.

In the following all options of the setup menu are explained in detail.

7.1 Set Monitor

Push the **set** key on the front panel longer than two seconds to enter the setup menu and get to the settings of the monitor loop. Push the **up** key to activate the monitor loop. If you would like to deactivate the monitor loop, please push the **down** key.

```
SET MONITOR:  
active
```

The 2nd line of the display informs the user about the current status of the monitor loop:

disabled The monitor loop is disabled.

active The monitor loop is active.

In normal operating mode, the symbol **M** at the end of the 1st display line indicates an active monitor loop. Also, the input channel name is now replaced by the (user-definable) name of the monitor loop.

```
5 TAPE MONITOR M  
LEVEL -46+0dB
```

- 1 currently selected input channel
- 2 user-definable name for the monitor loop
- 3 indicator for active monitor loop



Note

- If the monitor loop is active the current input channel stays selected. But the signal from the monitor input [17] is routed to the outputs.
- The name for the monitor loop is user-definable as well as the input channel name (see section '*Channel name*' on page 28). The name for the monitor loop is restricted to 12 characters in length.

7.2 Set Headphones

Press and hold the **set** key for longer than 2 seconds to enter the setup menu. Then push the **set** key once to get to the headphones settings. Now use the keys **up** and **down** to select the desired option.

**SET HEADPHONES:
HP off & Link on**

The 2nd line shows the status of the headphones output:

HP off & Link on Headphones output **HEADPHONES** [4] is disabled. The 'Audionet Link' output **OUT 2** [19] is switched on/off with the PRE1 G3 switching on/off.

HP on & Link on Headphones output **HEADPHONES** [4] is active. The 'Audionet Link' output **OUT 2** [19] is also active as long the unit is switched on. Use this option if you connect devices to the 'Audionet Link' output **OUT 2** [19] that are supposed to be controlled via 'Audionet Link' independently from the headphones setting.

HP on & Link off Headphones output **HEADPHONES** [4] is active, but the 'Audionet Link' output **OUT 2** [19] is **always** switched off. Use this option if you would like to switch off amplifiers, that are connected to the 'Audionet Link' output **OUT 2** [19], automatically while you are using the headphones output.

The display indicates an active headphones output by the symbol  in the 2nd line:

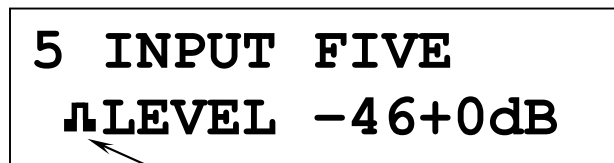

indicator headphones output active



Important

- In contrast to all other menu items, the settings for the headphones output and the 'Audionet Link' output **OUT 2** 19 are not updated immediately when you change the setting. This is to avoid amplifiers, connected to the 'Audionet Link' output **OUT 2** 19, switching on/off while the user is stepping through the options of the headphones settings.

The selected option will be activated as soon as you leave the menu by holding the **set** key down for longer than two seconds or waiting about 12 seconds without any entry, or navigating to the next menu item by pushing the **set** key less than two seconds.



Tip

- If you connect your power amplifier to the 'Audionet Link' output **OUT 2** 19 of the PRE1 G3, it will be switched off automatically as soon as you select the headphones option **HP on & Link off**. Thus, you are able to enjoy music with your headphones and need not to worry about the amplifier.

In case you deactivate the headphones output by selecting the option **HP off & Link on**, the power amplifier is switched on automatically via 'Audionet Link', so you playback music through your speakers again.

7.3 Set Dim Level

Press and hold the **set** key for longer than 2 seconds to enter the setup menu. Then push the **set** key three times to adjust the brightness of the display on the front panel of the PRE1 G3.

Now use keys **up** and **down** to select the desired brightness. Key **up** increases, key **down** decreases the brightness.

Additionally, the display shows the current brightness level in percent and by a bar of corresponding length:



current brightness level in



Important

- **Long-term usage of the display set to maximum brightness (setting 100%) may cause extended signs of wear resulting in a decay of contrast or brightness of individual dots in the display. Do not use the display with a brightness set higher than the factory default of 50% over a longer period of time!**



Note

- Is the brightness set to **Off** the display is only on during setup or volume adjustments. It switches off automatically several seconds after the last user entry.
- The PRE1 G3 activates the 'display saver' automatically after 10 minutes without any user entry.
- During active 'display saver', the display shows only the number of the selected input channel and current volume level in the form of **In 4 -47dB**. The display brightness is always reduced to 25%, and the location of the information text will change randomly every 12 seconds to prevent any 'burn-in' effect of the display.
- The 'display saver' is de-activated and the display returns to its normal mode as soon as any user entry is detected
- The user cannot switch off the automatic 'display saver' function!

7.4 Balance Adjust

Press and hold the **set** key for longer than 2 seconds to enter the setup menu. Then push the **set** key four times. The display reads now:

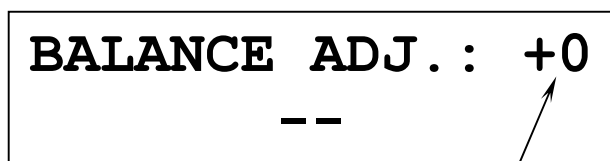

current balance setting in dB

Now adjust the balance by using the keys **up** and **down**.

Use the **up** key to shift the balance to the right. The 1st line of the display shows the volume difference in dB between left and right channel. A positive value means that the balance is shifted to the right.

Use the **down** key to shift the balance to the left. The value in the display is now negative.

The PRE1 G3 allows the user to shift the balance up to 9 dB to the left or the right in steps of 1 dB.

The 2nd line of the display visualises a balance shift with one or more symbols. The orientation of the symbol represents the direction of the balance shift, the number of symbols equals the amount of 1 dB steps the balance was shifted.

Example:

- ▶▶▶ balance shifted to the right by 3 dB
- ◀◀◀◀◀ balance shifted to the left by 5 dB
- no balance shift



Note

- In normal operating mode the PRE1 G3 indicates a balance shift by the corresponding symbol in the 2nd line of the display. Thus you are able to see at any time if the balance was shifted:

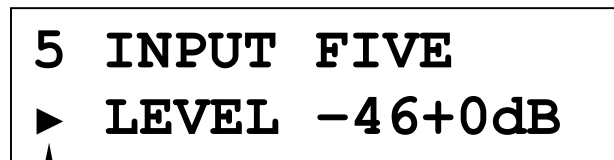

- ▶ = balance shifted to the right
- ◀ = balance shifted to the left

- A balance shift is carried out internally by attenuating the corresponding channel, i.e. if the balance is shifted to the right, the level of the left channel is attenuated and vice versa.

7.5 Offset Adjust

Press and hold the **set** key for longer than 2 seconds to enter the setup menu. Then push the **set** key five times to get to the offset adjustment.

Use the **up** key on the front panel to increase the level of the currently selected input channel. If you would like to decrease the offset level, use the **down** key. The display informs you of your selection:

**5 INPUT FIVE
LEVEL -46+3dB**

offset adjustment in dB

For each of the six input channels and for the monitor loop of the PRE1 G3 you can define the adjustment of the input level in the range of -9 dB to +9 dB in steps of 1 dB to match the different output levels of sources connected to the PRE1 G3.



Tip

- To adjust the offset of the monitor loop you first have to activate the loop (see section '*Set Monitor*' on page 22). Now you adjust the offset as described above for the offset of the input channels.

7.6 Set DC Servo

Press and hold the **set** key for longer than 2 seconds to enter the setup menu. Then push the **set** key six times to adjust the DC Servo option.

Push the **up** key to activate the DC Servo for the currently selected input channel. To disable the DC Servo push the **down** key.

**SET DC SERVO:
In 3 : disabled**

currently selected input channel

status DC Servo

disabled The DC Servo is disabled for the currently selected input channel

active The DC Servo is active for the currently selected input channel.

Activate the DC Servo only in cases where the source connected to the PRE1 G3 holds a high DC component in its output signal. The DC Servo eliminates the DC component. The currently selected input channel is now AC-coupled. Usually the DC Servo may be disabled.



Note

- In normal operating mode the display indicates an active DC Servo for the currently selected input channel by a symbol right beside the volume level in the 2nd display line. Thus you can see at any time if the DC Servo is active:

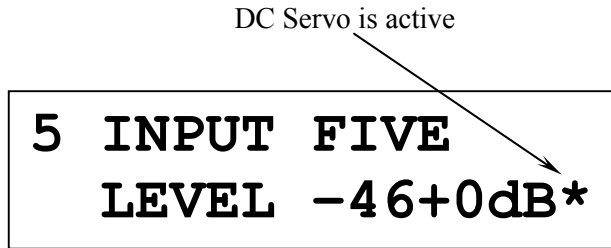

7.7 Channel name

You can assign a fully user-definable name up to 14 characters in length to each of the six input channels. Press and hold the **set** key for longer than 2 seconds to enter the setup menu. Then push the **set** key seven times. The display will then show the number of the currently selected input channel and the assigned channel name. The cursor in the 2nd line of the display marks the character you now may alter.

Use the keys **up** and **down** on the front panel to select the desired character. Hold **set** key down for longer than two seconds to move the cursor one step to the right. After the last position the cursor wraps around and starts at the first position again.

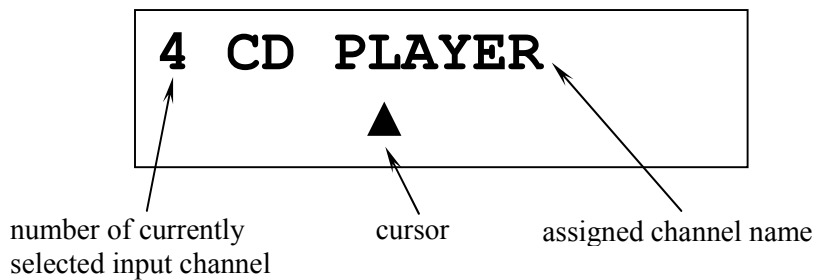

Note

- The name of the monitor loop is also user-definable (up to 12 characters in length).
To edit the name of the monitor loop you first have to activate the loop (see section 'Set Monitor' on page 22). Then edit the name of the monitor loop as described above for editing the input channel name.

- If the monitor loop is active, you are able only to edit the name of the monitor loop. You have to deactivate the monitor loop first, before you are able to edit the input channel names again.

7.8 Set Out 2 (Sub)

Press and hold the **set** key for longer than 2 seconds to enter the setup menu. Then push the **set** key eight times to select the format of the output signal of Cinch output **OUT 2** 7.

Push the **up** key on the front panel to select the mode **Subwoofer** for the output **OUT 2** 7. If you would like to select the mode **Left & Right** push the **down** key.

SET OUT 2 (SUB) :
Subwoofer

selected mode for output **OUT 2** 7

Left & Right Left and right channel are routed to the Cinch output **OUT 2** 7. Therefore, output **OUT 2** 7 offers the same signal as output **OUT 1** 6.

Subwoofer The mono sum signal of channels left and right is output on both jacks of output **OUT 2** 7 for driving a subwoofer.



Note

- In mode **Subwoofer** the mono sum signal is composed by the formula: $\frac{1}{2} * (\text{Left} + \text{Right})$.



Tip

- If your subwoofer offers only one cinch input jack, select mode **Subwoofer** in the menu **Set Sub Out** and connect one of the jacks of output **OUT 2** 7 to the input of your subwoofer.
- Consult the manual of your subwoofer.
- If you would like to use the output **OUT 2** 7 as fully-fledged stereo output (e.g. for driving power amplifiers), select mode **Left & Right**.

7.9 Set Autostart

Press and hold the **set** key for longer than 2 seconds to enter the setup menu. Then push the **set** key nine times to get to the Autostart option.

Push the **up** key on the front panel to activate the Autostart function. If you like to deactivate the Autostart function push **down** key.



SET AUTOSTART:
active

status of the Autostart function

disabled The Autostart function is disabled. After switching on the mains switch **1** on the back panel, the PRE1 G3 enters the stand-by mode. You have to use the **power** key on the front panel or key **PRE** on the Audionet Metal Remote Control *RC 1* or *RC 2* to switch on the unit into normal operating mode.

active The Autostart function is active. As soon as you connect the PRE1 G3 to mains (i.e. use the mains switch **1** on the back panel) the unit starts up automatically to normal operating mode. Use this setting for timer controlled operations.

7.10 Set Channel for By-Pass Mode

Press and hold the **set** key for longer than 2 seconds to enter the setup menu. Then push the **set** key ten times to get to option for selecting the input channel dedicated to the By-Pass Mode.

Use keys **up** and **down** on the front panel to select the input channel you would like to use in By-Pass Mode.



SET CHANNEL FOR
BY-PASS MODE: 3

input channel no. 3 is used in By-Pass Mode



Important

- Before you can use the By-Pass Mode you have to select the input channel that is used for the By-Pass Mode.
- For safety reasons the factory default settings have **no** input channel selected for By-Pass Mode (display: **SET CHANNEL FOR BY-PASS MODE: - -**).

The By-Pass Mode was primarily intended to integrate the overwhelming sound quality of the PRE1 G3 into an existing home cinema setup or to expand an existing excellent stereophonic system based on the PRE1 G3 to a complete home cinema setup without missing out on the qualities of the PRE1 G3. To realise this kind of setup, please proceed as follows:

1. Connect your home cinema pre amplifier according to its user's manual.
2. Connect the output for the front channels Left and Right not to the power amplifier but to one of the free inputs (except input 6 'PHONO IN') of the PRE1 G3.
3. Now connect the outputs of the PRE1 G3 to the corresponding power amplifier for the channels Left and Right.
4. Use menu item 'Set Channel for By-Pass Mode' of the setup menu of the PRE1 G3 to select the input channel for By-Pass Mode you connected the outputs Left and Right of the home cinema pre amplifier to.
5. Connect now all high quality 2-channel analog sources to the remaining inputs of the PRE1 G3.
6. Connect your DVD player to your home cinema pre amplifier as usual.

Use the PRE1 G3 to listen to high quality analog sources. If you would like to use your home cinema system activate the By-Pass Mode of the PRE1 G3 and use your home cinema pre amplifier as usual.



Important

- **Please read the complete section about the special function By-Pass Mode first before you use this function in order to prevent maloperations and possible damage to your audio system and/or hearing.**
- **By factory default no input channel is selected for the By-Pass Mode. Use menu option 'Set channel for By-Pass Mode' to select desired input channel for the By-Pass Mode.**

While the By-Pass Mode is active the volume control of the PRE1 G3 is by-passed. The PRE1 G3 passes through the input signal to the outputs with its **full** level.

The special function By-Pass Mode of your PRE1 G3 is activated automatically if you switch to the input channel dedicated to the By-Pass Mode in the setup menu item **Set Channel for By-Pass Mode**. The signal at the input channel selected for By-Pass Mode operations is passed through the PRE1 G3 at a level of 0 dB (i.e. no change in volume level) to the outputs.

As soon as you select a different input channel, the special function By-Pass Mode is switched off automatically. The volume is reset to the prior level.



Important

- **Please check the correct connection and setup before you use the By-Pass Mode for the first time. The input signal will be passed through to the outputs at full level!**

As soon as the By-Pass Mode is activated, the PRE1 G3 will ignore all control commands coming from the keys on the front panel or remote control (exceptions see below)!



Important

There are only two possibilities to disable the By-Pass Mode:

1. Select a different input channel. The PRE1 G3 switches back to the newly selected input channel selected before resetting the volume to its prior level.
2. Push the **power** key on the front panel or the **PRE** key on the Audionet Metal Remote Control *RC 1* or *RC 2*. The PRE1 G3 switches off to stand-by mode.



Note

- If you leave the By-Pass Mode by pushing the **power** key on the front panel or **PRE** key on the Audionet Metal Remote Control *RC 1* or *RC 2*, this mode will be saved, i.e. if you switch on the PRE1 G3, the unit will switch to the last saved input channel selection and thus into By-Pass Mode.

7.11 Set DC Servo for By-Pass M.

Press and hold the **set** key for longer than 2 seconds to enter the setup menu. Then push the **set** key eleven times to get to settings for the By-Pass Mode.

Push the **up** key on the front panel to activate the DC Servo for the By-Pass Mode. If you like to deactivate the DC Servo for the By-Pass Mode push **down** key.



SET DC SERVO FOR
BY-PASS M. : off

DC Servo for the By-Pass Mode is switched off

off The DC Servo for the By-Pass Mode is switched off.

on The DC Servo for the By-Pass Mode is switched on.

Activate the DC Servo only in cases where the source connected to the PRE1 G3 holds a high DC component in its output signal. The DC Servo eliminates the DC component. The input channel dedicated to the By-Pass mode is now AC-coupled. Usually the DC Servo may be disabled.



Note

- The setting of the DC Servo for the By-Pass Mode is completely independent to the DC Servo settings for the input channels.
- While the PRE1 G3 is in By-Pass Mode the display indicates an active DC Servo by a '*' in the upper right corner:

DC Servo is active

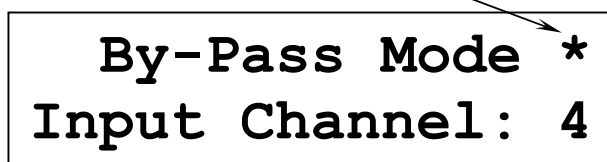

By-Pass Mode *
Input Channel: 4

7.12 Overview factory defaults

Option	Setting
SELECT INPUT	INPUT TWO
SET MONITOR	disabled
SET HEADPHONES	HP off & Link on
SET DIM LEVEL	50%
BALANCE ADJ.	- -
OFFSET ADJUST	0 dB (for all input channels)
SET DC SERVO	In 1-5: disabled In 6: active
Channel name	1: BALANCED 2: INPUT TWO 3: INPUT THREE 4: INPUT FOUR 5: TAPE INPUT 6: PHONO IN
SET OUT 2 (SUB)	Left & Right
SET AUTOSTART	disabled
SET CHANNEL FOR BY-PASS MODE	- -
SET DC SERVO FOR BY-PASS M.	off

8 Audionet Metal Remote Control

The Audionet Metal Remote Control *RC 1* (included) or *RC 2* controls all the important function of everyday use of your PRE1 G3. The following explains all these commands in detail.

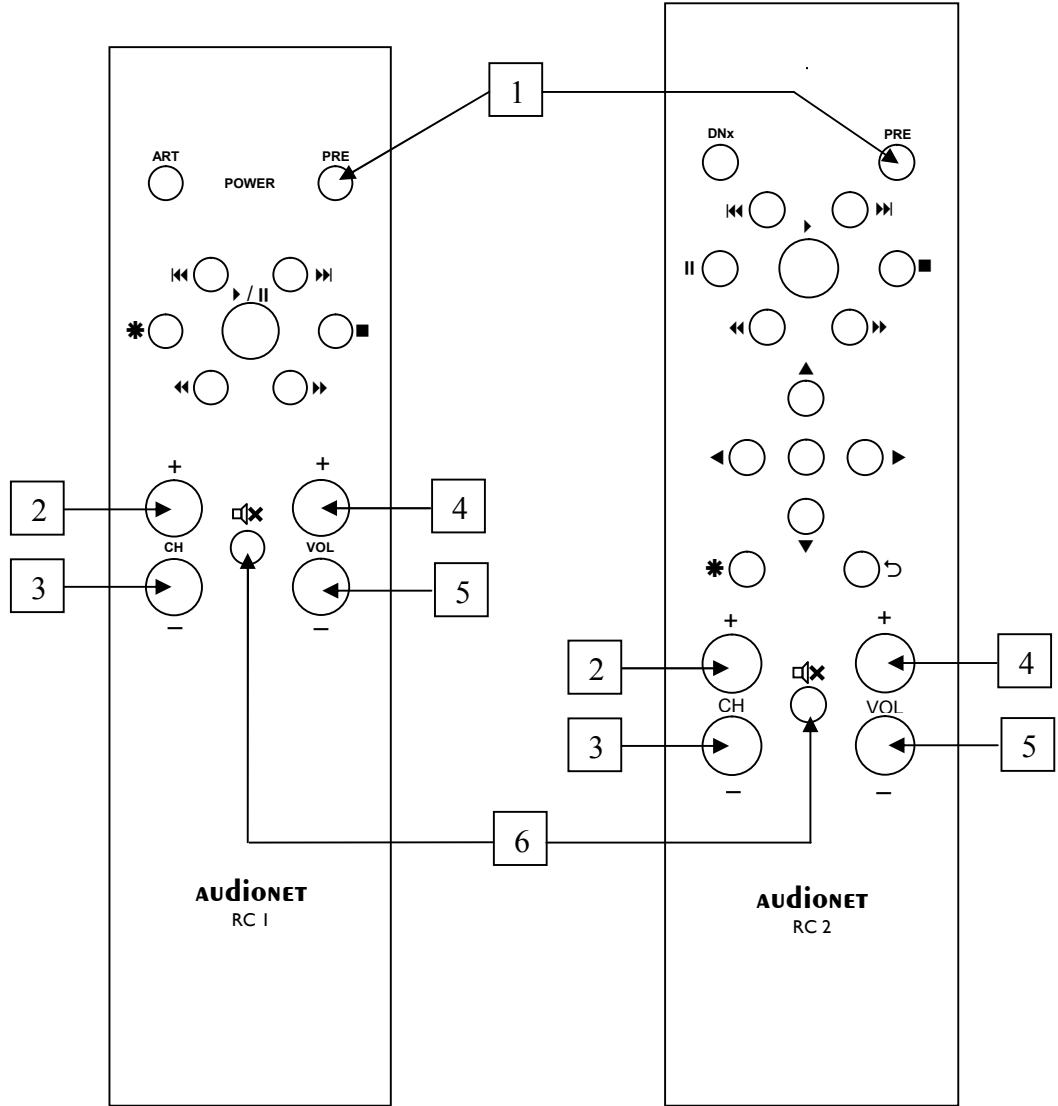

8.1 Key assignment PRE1 G3

1 Power key **PRE**

use the key **PRE** to switch on / off your PRE1 G3. This key has the function as key **power** on the front panel. If the PRE1 G3 is in stand-by mode, press key **PRE** to switch on this unit. If the PRE1 G3 is already switched on, then pressing **PRE** powers the unit down to stand-by mode.

2 Key **CH +**

selects the next input channel of the PRE1 G3.

3 Key **CH -**

selects the previous input channel of the PRE1 G3.

4 Key **VOL +**

increases the volume of the PRE1 G3.

5 Key **VOL -**

decreases the volume of the PRE1 G3.

6 Mute key

mutes the PRE1 G3. Press again to resume last volume level.

8.2 Changing the batteries

In order to exchange the batteries of your Audionet Metal Remote Control *RC 1* or *RC 2*, first you have to remove the 6 Phillips head screws on the bottom side.

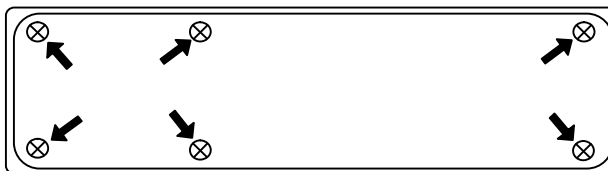

The battery compartment is to the left side of the circuit board. You need 2 batteries type 'AAA' or 'Micro' with a voltage of 1.5V.

Battery compartment





Important

- While inserting the batteries please mind their orientation. The correct orientation is printed onto the bottom of the battery compartment.

8.3 Settings for Audionet preamplifier

The Audionet Metal Remote Control *RC 1* or *RC 2* has 6 keys to control an Audionet (pre-) amplifier like the PRE1 G3. The previous section '*Key assignment PRE1 G3*' explains the function of these keys.

Depending on their type, Audionet (pre-) amplifiers use different system addresses for their remote control code. A DIP switch on the circuit board of the Audionet Metal Remote Control *RC 1* or *RC 2* selects the desired system address.

In order to set the system address you first have to open up the remote control (see section '*Changing the batteries*' on page 36).

For Audionet Metal Remote Control *RC 1* the DIP switch for selecting the system address is located here:

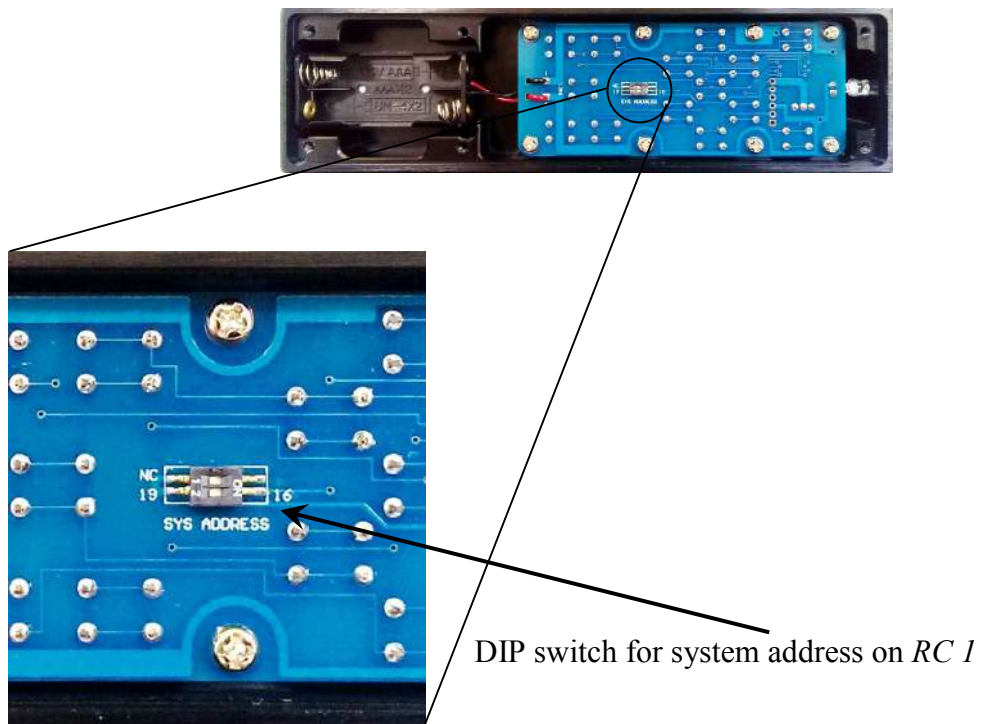

For Audionet Metal Remote Control *RC 2* the DIP switch for selecting the system address is located here:

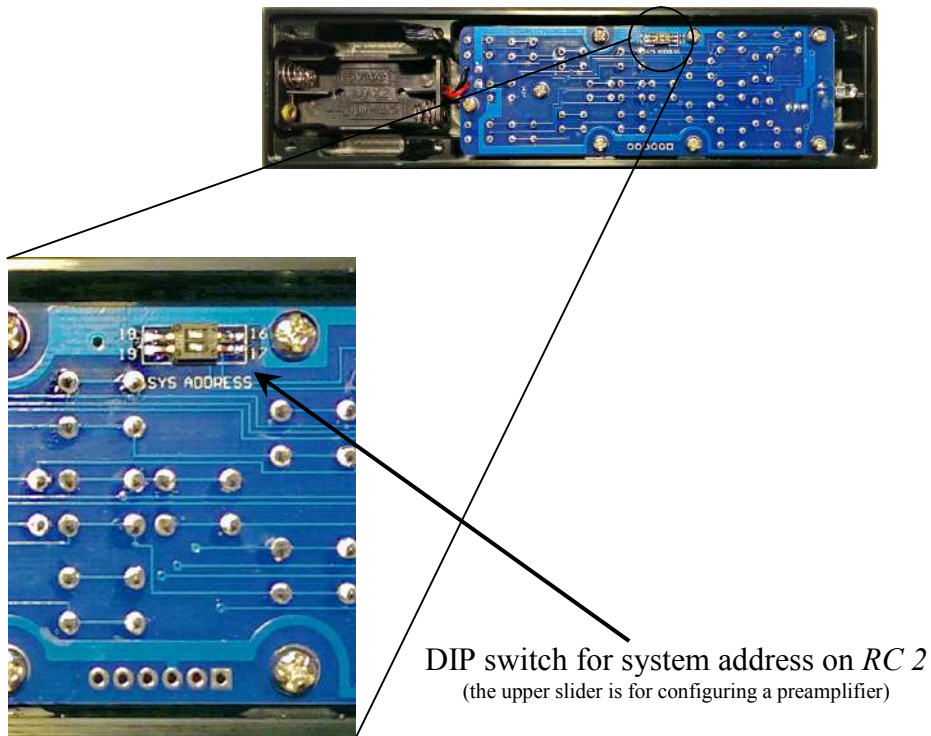

Put the DIP switch labelled 'SYS ADDRESS' in position '19' or '16' according to the following table:

Audionet preamplifier	Address
PRE G2, PRE 1 G3 , SAM G2, DNA, DNP, DNA 1	19
MAP 1	16



Note

- If not ordered explicitly, the Audionet Metal Remote Control is pre-configured to setting '19' of the DIP switch.
- Older models of Audionet preamplifiers use system address 16.
- Audionet Metal Remote Control *RC 2* uses both slider switches of the DIP switch. The one for configuring the preamplifier is the upper one with the left side labelled '19' and the right side labelled '16'.

9 Technical information

9.1 Design

With circuits consequently designed using SMD miniature technology and shortening all signal paths to a minimum the high frequency characteristics were optimized. Ground pathways run in a star-shaped pattern converging in one central location. The circuit design is optimized capacitively and inductively. A powerful microprocessor controls and monitors the system. The analog section and control unit are galvanically separated by opto-couplers, the digital section also spatially separated.

9.2 Power supply

A 50 VA toroid transformer powers high-current capacitors with a total capacity of 20,000 μ F. Two fast, discrete pre-regulators smooth and stabilize the supply voltages. Additionally the voltages for the input and output stage each are smoothed locally by two discrete and ultra-fast regulators. The digital section has a separate power supply.

9.3 Circuitry

All operational amplifiers optimized and embedded in a discrete circuitry. The driver stage operates distortion-free in symmetric class A mode. Gold-coated precision relays switch the input signal and ground. Volume and balance is controlled, free of any electro-mechanical component, via precision resistor networks that are switched electronically and linearized in real-time. The resolution of the volume control circuit is 1 dB.

9.4 Handling

A microprocessor controls and monitors all functions. A two line, 16-digit display informs the user about all operating modes and makes it easy to adjust the PRE1 G3 to the user's preferences. The unit also features user-definable channel names and input level adjustment for each channel. Two 'Audionet Link' outputs facilitate easy daisy-chaining of Audionet devices for remote switching on/off via 'Audionet Link'. Each input channel features a user selectable DC Servo to eliminate DC components on source signals. Furthermore a monitor loop for an additional recorder, decoder etc. is present.

The PRE1 G3 can be equipped with the Audionet Metal Remote Control *RC 1* or *RC 2*, a phono module for MM- and MC-systems, and two different external power supplies, the EPS and the EPX.

10 Security advice



Important

- Avoid packaging material, especially plastic bags, coming into children's hands!
- Store and operate the unit in a dry room at a reasonable room temperature only!
- Avoid moisture, any liquids, dirt or small objects getting into the unit!
- Set up the unit in a sufficiently ventilated environment!
- Do not cover the unit!
- Do not open the unit. Unauthorised opening will void warranty!
- Do not short-circuit the outputs!
- During connecting or removing the PRE1 G3 to/from sources and/or power amplifiers all units have to be switched off to prevent damage of the PRE1 G3 or any of the other connected units.
- Use dry cloth for cleaning!

We would like to wish you many exciting listening experiences with your new Audionet product.

If you still have any questions, do not hesitate to ask your competent Audionet dealer or contact us directly

11 Technical data

Function	microprocessor controlled pre-amplifier
Frequency response	0 – 3,000,000 Hz (-3 dB), DC coupled 2 – 3,000,000 Hz (-3 dB), AC coupled, 1 st order DC servo
THD+N	>108 dB, 20 Hz - 20 kHz, for $V_{in} = 5 V_{RMS}$
SNR	> 120 dB relative to $V_{in,max}$
Slew Rate	10 V/ μ sec
Channel separation	between channels > 100 dB @ 20 kHz between inputs > 108 dB @ 20 kHz
Inputs	5 pair Cinch line, gold plated 1 pair XLR balanced, gold plated 1 pair Cinch Monitor, gold plated 5-pin connector for EPS
Input impedance	line input 82 k Ω real XLR (balanced) input 15 k Ω real
Input voltage	max. 5 V_{RMS}
Outputs	1 pair Cinch line, gold plated 1 pair XLR balanced, gold plated 1 pair Cinch Rec Out, gold plated 1 pair Cinch Monitor, gold plated 2 Audionet Link, optical 1 connector, gold plated, for additional earth connection 1 trigger output, 12 Volts DC, 3.5mm telephone jack
Output impedance	line and balanced out 22 Ω real headphones out 47 Ω real
Output voltage	line out max. 8 V_{RMS} XLR (balanced) out max. 16 V_{RMS} headphones out max. 8 V_{RMS} (max. gain = 6 dB)
Mains	220..240 V or 110..120 V, 50..60 Hz
Power consumption	< 1 W Stand-by, max. 30 Watts
Dimensions	Width 430 mm Height 72 mm Depth 420 mm
Weight	6 kg

Finish	<p>Front: brushed aluminium, black anodised, white print or aluminium 'nature', anodised, black print</p> <p>Display: red or blue</p> <p>Top cover: brushed aluminium, microlised</p> <p>Chassis: steel, black coated</p>
Features	<ul style="list-style-type: none"> - remote control (not included) - automatic detection of main polarization - separate power supply for digital and analog sections - electronically switched and real time linearised precision resistors for volume control - audio and control functions optically decoupled - full DC coupling, no capacitors in the signal path - selectable AC coupling via DC servo - separate level adjustment for each input channel - By-Pass function (e.g. for integration into home cinema systems) - Auto start function for timer operations - Audionet Link outputs for remote control of other Audionet components (e.g. power amplifiers) - selectable headphones output
Options	<ul style="list-style-type: none"> - Phono module for MM and MC pickups - external precision power supply Audionet EPS or EPX

Errors and omissions excepted. Specifications and design are subject to changes without prior notice.

AUDIONET

audionet GmbH

Brunsbütteler Damm 140 B

13581 Berlin, Germany

www.audionet.de

kontakt@audionet.de

Errors and omissions excepted. Specifications and design are subject to changes without prior notice.