

AUDIONET

HEISENBERG

Ultimate Linear Mono Power Amplifier



User's Manual

Contents

I	Preface	4
1.1	Included items	5
1.2	Transport	5
2	Overview front panel	6
3	Overview back panel	7
4	Installation and power supply	8
4.1	Placement	8
4.2	Mains connection	9
4.3	Orientation of mains plug	10
5	Inputs and outputs	11
5.1	Inputs	11
5.2	Speaker terminals	11
5.3	Bi-Wiring	12
5.4	Audionet Link	12
6	Operating	14
6.1	Powering up	14
6.2	Switching on and off	14
6.3	Using Audionet Link	15
6.4	Auto Power Off function	15
6.5	Operation indicator	16
7	Protection system	17
8	Setup	19
8.1	Input Select	19
8.2	Auto Power Off	20
9	Technical information	21
10	Security advice	23
11	Technical data	24

I Preface

The Audionet Scientists Team and its leading scholars congratulate you on your purchase of this unit, sending cheers directly from our research and development center.

Audionet components are no marketing products, they are authentic. Conceived and developed with scientific inspiration, professional engineering expertise and a deep passion for achieving the truly perfect sound. They are unique creations designed to inspire musical enjoyment and have an excellent reputation amongst all connoisseurs throughout the world. Each and every one of our precision-manufactured devices is individually crafted by hand at our new Berlin headquarters. Built by audiophiles for audiophiles. With the utmost precision and total control of each and every perceptible detail.

Even if you're an experienced aficionado of ultra-highend components, please start listening to your new Audionet HEISENBERG by reading this manual carefully before you plug it in. This will ensure you'll enjoy all functions of this unit without any compromise or potential disruption.

1.1 Included items

You will find the following items included:

- Mono power amplifier HEISENBERG
- Power cord
- 1 Toslink cable
- Cover bag
- Gloves, 2 pairs
- User's manual (that you are currently reading)
- Red warning note
- Fumigation certificate

1.2 Transport



Important

- Only transport the HEISENBERG in the original packaging.
- Always use the provided cloth bag to prevent scratches on the casing.
- Please allow the HEISENBERG to adapt to the climatic conditions in your listening room before you switch the unit on for the first time after the transport.

2 Overview front panel

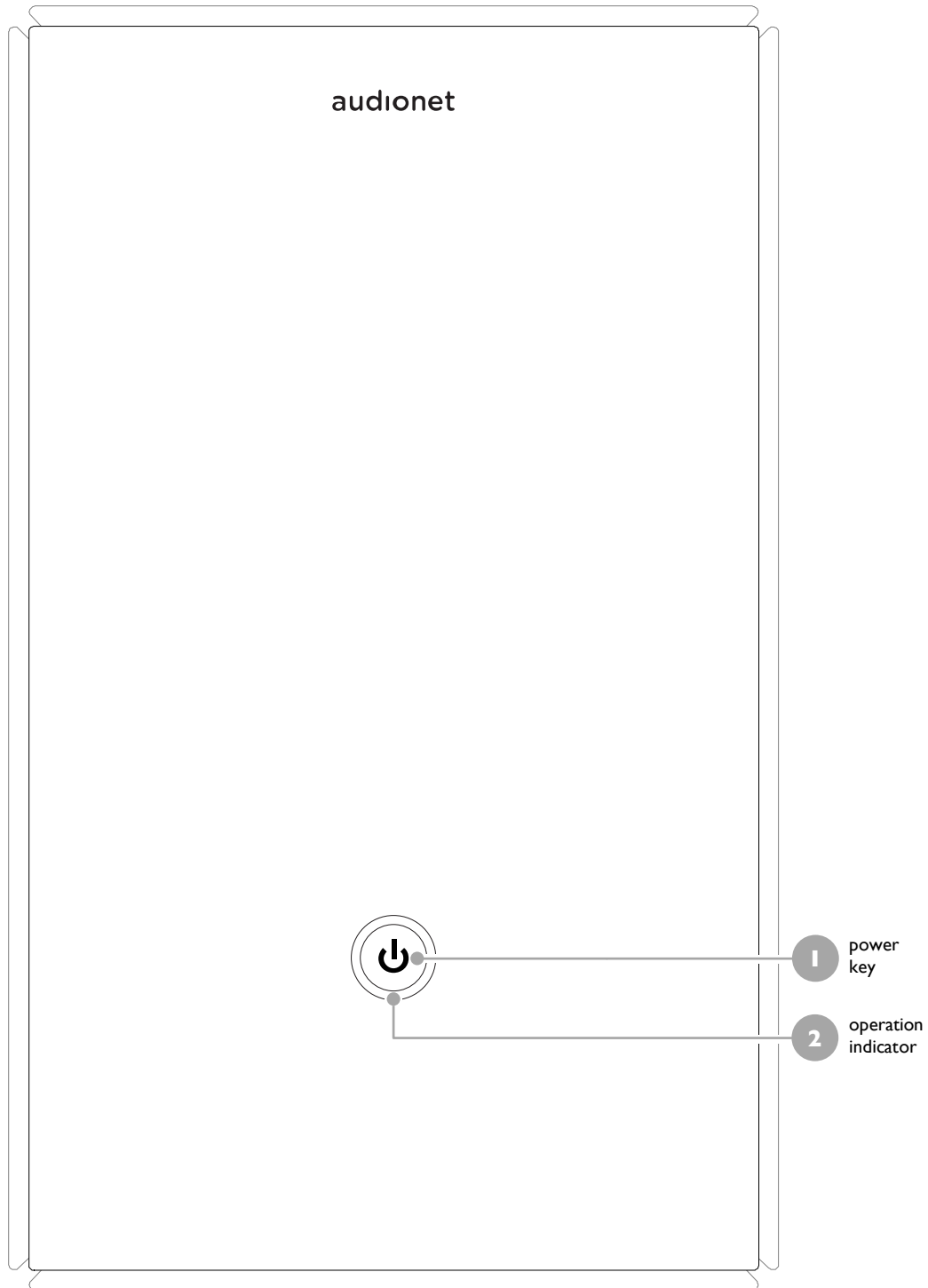

3 Overview back panel

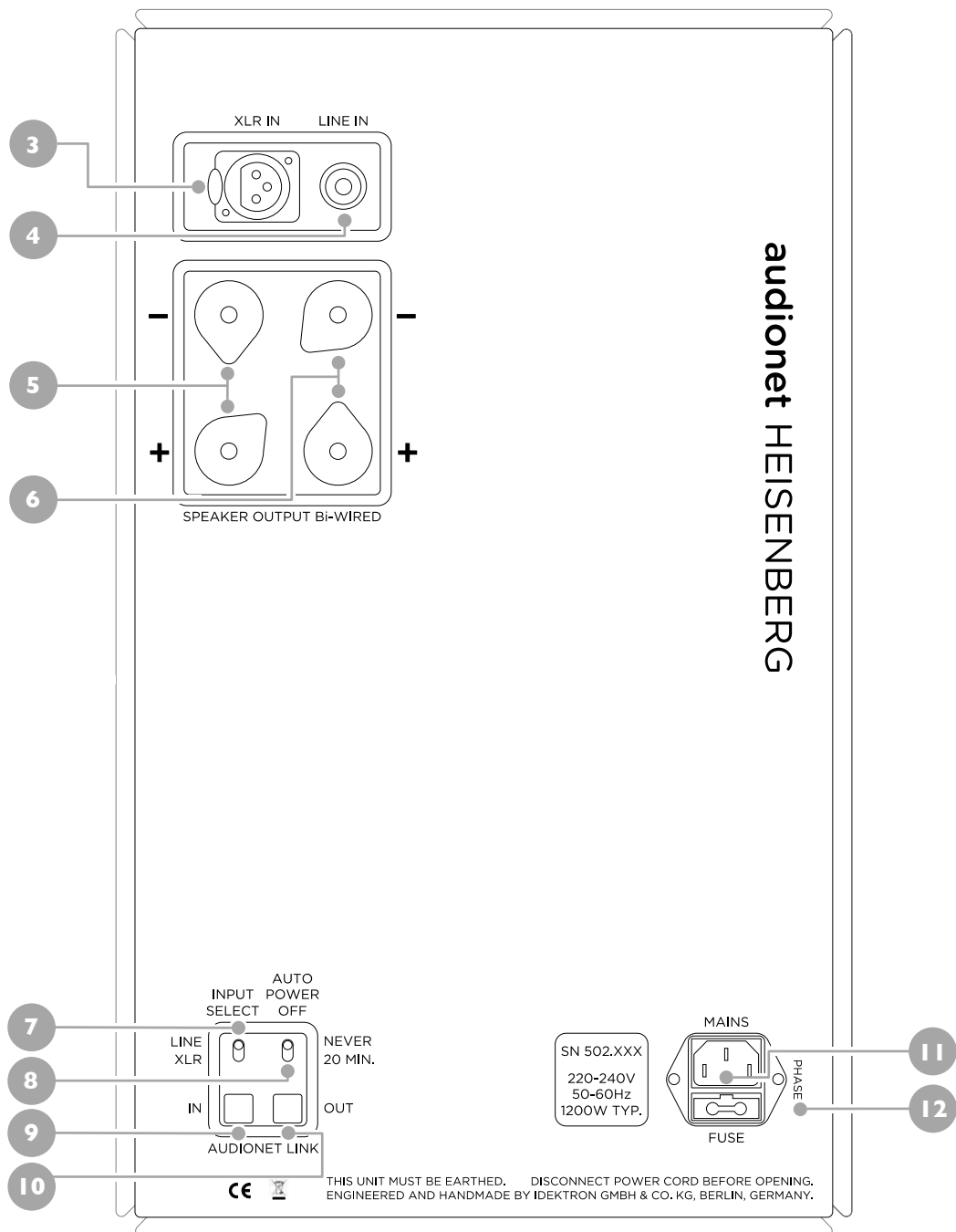

- | | | | |
|----------|------------------------|-----------|-------------------------|
| 3 | balanced (XLR) input | 8 | 'Auto Power Off' switch |
| 4 | line (cinch/RCA) input | 9 | 'Audionet Link' input |
| 5 | speakers output 1 | 10 | 'Audionet Link' output |
| 6 | speakers output 2 | 11 | mains input |
| 7 | input switch | 12 | 'mains phase' marking |

4 Installation and power supply



Important

- For connecting or removing loudspeakers and/or the preamplifier, your HEISENBERG must be switched off to prevent damage to the amplifier or the connected units.
- Please make sure that all cables are in absolute best conditions! Broken shields or short-cut loudspeaker cables could damage the speaker, the HEISENBERG and/or any other units connected.

4.1 Placement

Your Audionet HEISENBERG has the perfect format for placing it right beside your speakers. It is recommended to place the HEISENBERG into a high quality rack or onto a stable table.



Important



- Please find a place for your Audionet HEISENBERG that is sufficiently ventilated to allow the heat to dissipate.
- Do not expose the unit to direct sunlight.
- Do not place the HEISENBERG in close range to heat sources like radiators.
- Do not cover the ventilation slots.

4.2 Mains connection

The mains input  * is on the back panel of the HEISENBERG. Use the included power cord to connect the unit to mains. If you prefer to use a different power cord, make sure that it meets the specifications for your home country.



Important

- The electrical specifications of your home country must meet the electrical specifications printed onto the back panel.
- The HEISENBERG is a Class I unit and must be earthed. Please ensure a stable earth connection. The phase ('hot' pin) is marked on the back panel (PHASE) .
- Never pull the mains plug while the HEISENBERG is switched on! Before you disconnect the power cord off its socket  at the back panel, power down the unit to stand-by mode first.

The HEISENBERG should only be switched off from the mains in cases of extended absence (like vacations) or if massive trouble on the mains power is to be expected. Pull the mains plug off the mains input socket  to completely disconnect the unit from mains.



Tip

- The use of high quality power cords (e.g. Audionet PI000) could improve the sound quality of your Audionet HEISENBERG. Please refer to our website (www.audionet.de) or consult your local Audionet retailer for further information.

* Please refer to the sections "Overview front panel" on page 6 and "Overview back panel" on page 7.

4.3 Orientation of mains plug

The correct polarization of mains is important for reasons of audio clarity and stability. Please connect the power cord so that the hot pin of the wall outlet is connected to the pin of the mains input ⑪ marked with 'PHASE' ⑫.

5 Inputs and outputs



Important

- For connecting or removing loudspeakers and/or the preamplifier, your HEISENBERG must be switched off to prevent damage to the amplifier or the connected units.
- Please make sure that all cables are in absolute best conditions! Broken shields or short-cut loudspeaker cables could damage the HEISENBERG, the speakers and/or any other connected unit.

5.1 Inputs

At first, connect your preamplifier alternatively to inputs ③ or ④ of the HEISENBERG. You can use both a Cinch or a balanced (XLR) cable. For cable lengths exceeding 10 m we recommend the use of balanced cables.



Note

- Do not forget to select the correct input that you are using with the input selector switch ⑦ on the back panel of the unit. Switching the inputs is possible during operations.

5.2 Speaker terminals

Connect your speakers to the rhodium plated terminals on the back panel of the HEISENBERG. You may use both banana plugs or spades as well as simple cable ends. HEISENBERG features two electrically identical speaker terminals ⑤ and ⑥, which you may use alternatively. In case you would like to bi-wire your speakers, please refer to section 'Bi-Wiring' on page 12.

Fasten the speaker terminals until the torque stop clicks distinctly. The torque stop guarantees for the right fastening torque at all times to ensure a safe contact.



Note

- Look out for the correct connection of your speaker cables. Usually, the terminals of your speakers are marked '+' and '-'. The HEISENBERG uses the same marks.
- Wrong speaker polarization will result in severe loss of sound quality!



Important

- Although the HEISENBERG has an effective protection system to prevent damage to the circuits, always switch off the unit while working on the speaker and/or audio cables.
- The nominal loudspeaker impedance should be 2 Ohms or higher.
- Never use force or tools to tighten the terminal screws.

5.3 Bi-Wiring

If your speakers support bi-wiring, use two separate cables to connect each speaker to the output terminals 5 and 6 of the HEISENBERG. Impulse response and spatiality may improve significantly.



Note

- Please mind the correct polarization of the speakers!

5.4 Audionet Link

For your convenience, the HEISENBERG can be controlled remotely by one of Audionet's preamplifiers (e.g. STERN) using the 'Audionet Link' interface.

You only need a simple optical 'Toslink' cable to connect the 'Audionet Link' output of your Audionet preamplifier to the 'Audionet Link' input IN 9 of the HEISENBERG.

In case you would like to automatically switch on/off further Audionet units in your system (e.g. a second HEISENBERG) using the 'Audionet Link' interface, please connect the 'Audionet Link' output OUT ⑩ of your HEISENBERG to the 'Audionet Link' input of the next Audionet unit (e.g. power amplifier, CD player etc.) using a simple 'Toslink' cable.



Note

- The 'switch on' signal is issued to all further Audionet units daisy chained to the 'Audionet Link' output of your HEISENBERG with a little delay to avoid all units switching on at the same time – which could cause an overload of your mains fuse.

6 Operating

6.1 Powering up

First of all, please make sure your HEISENBERG is connected correctly to your preamplifier, speakers and mains (refer to sections 'Installation and power supply' on page 8 and 'Inputs and outputs' on page 11).

The HEISENBERG is a stand-by unit. Please insert the power cord into the mains input socket ① on the back panel. The operation indicator ② (light ring around the ⏻ key on the front panel) flashes white - red - white once. Afterwards the HEISENBERG is in stand-by mode.

The HEISENBERG should only be switched off from the mains in cases of extended absence (like vacations) or if massive trouble on the mains power is to be expected. Pull the mains plug off the mains input socket ① to completely disconnect the unit from mains.



Important

- Never pull the power cord while the HEISENBERG is switched on! Before you disconnect the power cord, power down the unit to stand-by mode first.

6.2 Switching on and off

Press the ⏻ key ① on the front panel to power up the HEISENBERG from stand-by mode. While powering up, the operation indicator ② will flash slowly in white colour. The unit is ready to play back music when the operation indicator ② shows white light permanently. HEISENBERG is in normal operating mode now.

If you would like to switch off the unit, please press the ⏻ key ① on the front panel. The operation indicator ② will flash in short white pulses until the power supply of the HEISENBERG is discharged completely. The unit is in stand-by mode when the operation indicator ② goes dark permanently.



Note

- While powering down, you may re-start the HEISENBERG by pressing the  key ① on the front panel. The operation indicator ② flashes slowly white until the unit is ready to play back music again.

6.3 Using Audionet Link

If your HEISENBERG is connected to an Audionet preamplifier via 'Audionet Link', use the preamplifier (e.g. with its remote control) to automatically switch the HEISENBERG on or off (and all other Audionet units connected via 'Audionet Link').

For setting up the necessary connections please refer to section 'Audionet Link' on page 12.



Note

- The 'switch on' signal is issued to any further Audionet unit daisy chained to the 'Audionet Link' output of your HEISENBERG with a little delay to avoid all units switching on at the same moment – which could otherwise cause an overload of your mains fuse.
- You may of course switch your HEISENBERG on or off at any time by using the  key ① on the front panel independently from the 'Audionet Link' interface.

6.4 Auto Power Off function

The Audionet HEISENBERG is equipped with an input signal detection circuit ('Auto Power Off' function). HEISENBERG will shut down automatically ('Auto Power Off' function) if no input signal is detected for a period of 20 minutes. To activate this feature please refer to section 'Auto Power Off' on page 20.



Note

- Because of the nature of stereo or multi-channel signals it may occur that the HEISENBERGs in your setup will switch off at a different point of time according to each input signal.
- Operate the HEISENBERG as usual. Of course, you are still able to switch on/off the unit manually.

6.5 Operation indicator

The operation indicator ² is a ring of light around the  key ¹ on the front panel. It indicates the current operating mode (see section 'Switching on and off' on page 14). In case of an error it displays the code of the detected malfunction (see section 'Protection system' on page 17).

The indications of all important operating modes are:

indication	duration	meaning
white – red – white	fast flashing	Response after connecting the unit to mains on the back panel. Unit is in stand-by mode afterwards.
flashing white	slow flashing	Unit powers up from stand-by mode.
permanently white	permanently on	Normal operating mode.
white flashes	short flash pulses	Unit powers down to stand-by mode, discharging power supply.
no indication	permanently off	Unit is in standy-by mode or switched off.
red flashes	short flash pulses	Error detected: unit powers down, discharging power supply. Error code will be indicated afterwards.
red flash code	flashes with pause before repetition	Error indication: the error number is flashing in red according to the detected error. The sequence is repeated after a pause until the  key is pressed.

7 Protection system

The Audionet HEISENBERG as well as the loudspeakers are protected by a complex protection circuitry. In case of a malfunction the operation indicator ② will flash the number of the error in red, i.e. you simply have to count the number of red flashes to determine the error number. It is paused for a longer period before the flashing error number is repeated, making it easier to count the number of flashes. The error number indication is repeated until the HEISENBERG is switched off by pressing the ⏻ key ① on the front panel.

Example:

The operation indicator flashes:

⊗ - ⊗ - ⊗ - ⊗ ————— ⊗ - ⊗ - ⊗ - ⊗ ————— ⊗ - ⊗ - ⊗ - ⊗ ...

4 flashes are counted after each pause. This corresponds to the error number 4.

The following table is an overview on all error numbers and their meaning:

error number	error	possible causes
1	overload	Short circuit or defect in loudspeaker.
2	DC voltage	High level of DC voltage at the output: defective preamplifier or source unit.
3	high frequency / clipping	High frequency oscillation: defective preamplifier. Clipping: amplifier or preamplifier are overdriven.
4	overheating	Cooling slots covered.
5	power failure	(Short) blackout of mains power.
6	pos. pre-voltage missing	Fuse blown or different fault in power supply: service case.
7	neg. pre-voltage missing	Fuse blown or different fault in power supply: service case.
8	pos. and neg. pre-voltage missing	Fuse blown or different fault in power supply: service case.
9	mains voltage error	Mains voltage is out of the permitted range of +/- 17% of nominal mains voltage; the unit switches off for security reasons or does not start up.
10	multiple errors	Multiple errors or unknown error detected.



Important

- As soon as an error is detected by the protection system, HEISENBERG powers down. The operation indicator ② shows short red pulses while the power supply is discharged – in contrast to the normal discharging, indicated by short white flashes. After the discharging is completed, the error code is flashed out by the operation indicator as described above.
- Remove the cause of the error prior to switching the HEISENBERG on again!

8 Setup

You are able to adjust the HEISENBERG to your preferences by using the two switches on the back panel of the unit (see section 'Overview back panel' on page 7).

List of settings to be adjusted according to your preferences:

- Input selection: balanced (XLR) or Cinch (INPUT SELECT)
- Auto Power Off function: automatic power down (AUTO POWER OFF)

8.1 Input Select

Select the input that you connected your preamplifier to:

LINE Select this option if you connected your preamplifier to the Cinch input **4** of the HEISENBERG.

XLR Select this option if you connected your preamplifier to the balanced (XLR) input **3** of the HEISENBERG.



Tip

Pinning of the balanced (XLR) input:

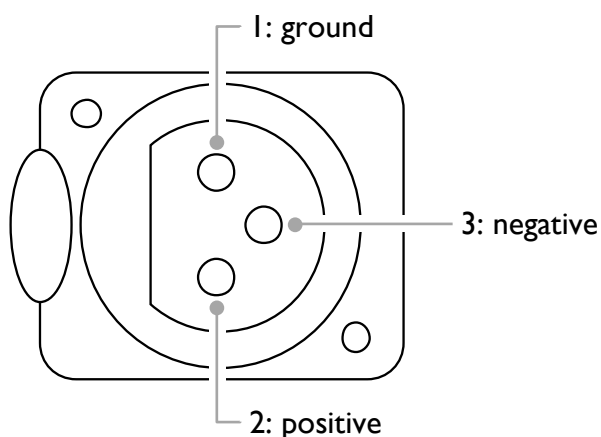

The pins are marked with the same number as in the image above.

8.2 Auto Power Off

The HEISENBERG will power down automatically (Auto Power Off function) when no input signal is detected on the selected input for a period of 20 minutes.

- NEVER** Select this option if you would like to deactivate the Auto Power Off function. The HEISENBERG will not shut down automatically if no signal is detected. You have to power down the unit to stand-by mode manually.
- 20 MIN** If no input signal is detected for longer than 20 Minutes, the HEISENBERG will shut down automatically.

9 Technical information

Special features of the HEISENBERG:

- Mono power amplifier for absolute channel separation.
- Magnetically and capacitively optimized circuit and device design without any ferro-magnetic materials.
- Floating Pane Design for optimal resistance against microphonic effects and temperature stability.
- The floating panels of the body are resonance-optimized by pads on an aluminum frame.
- Mounting and bolted assembly of transformers made of stainless steel.
- Air Flow Design circuit boards for an optimum of cooling and stable quiescent currents.
- Galvanic separation of all analog circuits by opto couplers.
- Audionet ULA technology (Ultra Linear Amplifier) for real-time linearization of distortions.
- Rhodium cinch jacks and rhodium torque speaker terminals by Furutech.
- DC coupled with no sound deminishing capacitors or coils, shortest signal paths.
- Lossless signal transport via massive, gold-plated copper rails to the speaker terminals.
- No speaker relays.
- Two separate power supplies for device control and detection & monitoring of zero-crossing of mains power.
- Four power supplies for positive and negative power supplies, separate for input & driver stage and power stage.
- Two encapsulated und decoupled 50 VA toroid transformers for input & driver stage.
- Two encapsulated and decoupled 1,200 VA toroid transformers for the power stage – ensuring a perfect power supply.

- Low impedance-optimized power capacitors with a total capacitance of 200,000 μF .
- Microprocessor controlled protection circuit with separate power supply, detecting high frequency, DC, overload and overheating.
- Rhodium fuse for mains and secondary side.
- Rhodium mains connector by Furutech.

10 Security advice



Important

- Avoid packaging material, especially plastic bags, coming into children's hands!
- Only store and operate the unit in a dry room at a reasonable room temperature!
- Avoid moisture, any liquids, dirt or small objects of getting into the unit!
- Set the unit up in a sufficiently ventilated environment!
- Do not cover the unit!
- Do not open the unit. Unauthorised opening will void warranty!
- Do not short-circuit the outputs!
- While connecting or removing the HEISENBERG to or from loudspeakers and/or the preamplifier, all units have to be switched off to prevent any damage of the amplifier or the other connected units.
- Use a dry cloth for cleaning!

We do wish you many exciting listening experiences with your new Audionet device.

If you still have any questions, do not hesitate to ask your Audionet retailer or contact us directly.

II Technical data

Type	Ultimate Linear Mono Power Amplifier
Output power	530 W into 8 Ω 1,050 W into 4 Ω 2,100 W into 2 Ω
Frequency response	0 - 700,000 Hz (-3 dB)
Damping factor	> 1,800 @ 10 kHz > 10,000 @ 100 Hz
Harmonic distortion	k2 typ. -117 dB for 25 W into 4 Ω k3 typ. -123 dB for 25 W into 4 Ω
Intermodulation	< -110 dB SMPTE 100 Hz : 20 kHz, 4 : 1, 50 W into 4 Ω
THD+N	> -106 dB @ 1 kHz, 25 W to 700 W into 4 Ω
SNR	> 125 dB
Filtering capacitance	200,000 μ F
Inputs	1 cinch (RCA) line, Rhodium plated, Teflon insulated (Furutech) 1 XLR balanced, gold plated (Neutrik) 1 Audionet Link, optical (TosLink)
Input impedance	Line input: 50 k Ω , 33 pF XLR input: 7 k Ω , 66 pF (line to line)
Outputs	2 pair speaker terminals, Rhodium plated, with torque guard (Furutech) 1 Audionet Link, optical (TosLink)
Mains	220..240 V or 110..120 V, 50..60 Hz
Power consumption	max. 2,400 W

Dimensions	width:	270 mm
	height:	500 mm
	depth:	490 mm
Weight	66 kg	
Finish	plates:	aluminum, 9 mm, pearl blasted, silver or black, text and icons printed black or white
	chassis:	brushed aluminum, black anodized

Errors and omissions excepted. Specifications and design are subject to changes without prior notice.

audionet GmbH

Brunsbütteler Damm 140 B
D-13581 Berlin

Fon +49 (0) 30 233 2421 0
contact@audionet.de

Errors and omissions excepted.
Specifications and design are subject
to changes without prior notice.