



M1.1 Two-channel Reference Power Amplifier

User Manual





Dear Valued Customer,

We are honored that you chose the M1.1 Power Amplifier for your audio system. Our team devoted every effort to design and manufacture this top quality versatile and future-proof product and is proud to present it to you. We hope your M1.1 Amplifier will bring you uncountable hours of emotion from your music collection.

But before you embark on your musical journey, we kindly request your attention to the information contained in this manual. The M1.1, as you will discover in the following pages, is a Swiss precision product designed for ultimate performance and flexibility. However, reaching sonic excellence requires your unit to be setup and operated correctly and this what this manual is all about. If you have any questions or require assistance, please don't hesitate to contact your authorized dealer.

We hope you will enjoy your M1.1 amplifier for many years.

The Concert has just begun...

Cossy F.

A handwritten signature in blue ink, consisting of a stylized 'C' followed by a sharp, downward-pointing stroke.

Heeb T.

A handwritten signature in blue ink, featuring a circular loop followed by a horizontal line extending to the right.





Table of contents

1	Technical highlights.....	7
1.1	Unmatched flexibility.....	8
1.1.1	Operation modes.....	8
1.1.2	Feedback ratio control.....	9
1.1.3	Gain control.....	9
1.1.4	Bias circuitry (ExactBias).....	9
1.2	Advanced monitoring circuit.....	9
1.2.1	Power monitoring.....	9
1.2.2	Temperature monitoring.....	10
1.3	Careful construction.....	10
1.4	Modular architecture and slot-in boards.....	10
1.4.1	Monaural analog inputs: ANALOG_IN board.....	11
1.4.2	Firmware update and control: CONTROL board.....	11
1.5	Power supply.....	11
2	Read carefully before use.....	12
2.1	Package content.....	12
2.2	Safety notice.....	12
2.3	User manual.....	13
2.4	Mains supply.....	13
2.5	Transport and packaging.....	13
2.6	Cleaning.....	14
2.7	Maintenance and service.....	14
3	Installation.....	15
3.1	Unpacking.....	15
3.2	Positioning your unit.....	15
3.3	Connections.....	16
3.3.1	CONTROL board.....	18
3.3.1.1	USB port.....	18
3.3.1.2	Ethernet port.....	18
3.3.2	ANALOG IN board.....	18
3.3.3	Power cord receptacles and voltage selection.....	19
3.4	Amplifier modes.....	19
3.4.1	Stereo mode.....	19
3.4.2	Monaural mode.....	19
3.4.3	Bridge mode.....	20
3.4.4	Passive bi-amplification mode.....	20
3.4.5	Active bi-amplification mode.....	21
3.4.6	Daisy-chain mode.....	22
4	Operation.....	23
4.1	Front panel controls.....	23
4.1.1	Front panel.....	23
4.1.2	Front panel push buttons.....	24
4.2	Operating modes.....	24
4.2.1	Normal mode.....	24
4.2.2	Shortcuts.....	26



4.2.3 Menu mode.....	28
4.3 Configuration.....	31
4.3.1 M1.1 configuration menu items.....	32
4.3.1.1 AUDIO SETTINGS.....	32
4.3.1.2 DISPLAY SETTINGS.....	33
4.3.1.3 SHORTCUTS.....	34
4.3.1.4 FACTORY SETTINGS.....	35
4.3.1.5 INSTALLED OPTIONS.....	36
4.3.1.6 NETWORK.....	36
4.4 Returning to factory defaults.....	37
5 Firmware update.....	38
5.1 Preparing the USB stick.....	38
5.2 Updating the unit's firmware.....	38
5.3 Emergency firmware update procedure.....	39
6 Troubleshooting.....	40
7 Specifications.....	41

1 Technical highlights

CH products are proudly designed and manufactured in Switzerland by CH Precision Sàrl. Our engineers put together all their know-how, expertise and ingeniousness to bring you the M1.1, a top performance future-proof modular two output channels power amplifier with USB flash-drive firmware update and Ethernet control capabilities. Like all CH Precision products, the M1.1 is highly versatile: up to 5 setups are possible: stereo mode (one M1.1 driving a pair of loudspeakers), monaural mode (the power transformer of the M1.1 is dedicated to one loudspeaker, only one output board is used), bridge mode (to nearly four times the available power), passive bi-amplification (each channel powers a specific loudspeaker driver or group of drivers) or active bi-amping (an active loudspeaker crossover is to be inserted between the preamplifier and the pair of M1.1s)

For increased flexibility, the M1.1 also provides two unique features: global/local feedback ratio and gain adjustments. The amount of global feedback in the amplifying loop of each channel can be adjusted to best match virtually any loudspeaker on the market. The amplifier gain can also be adjusted over a 24 dB wide range in 0.5 dB steps. This greatly helps matching the output level of the preamplifier, the efficiency of the connected loudspeakers and the listening room. Three standard input connectors are available (balanced XLR, single-ended RCA and BNC). Unbalanced inputs can be configured as high-impedance input, or a 300 Ohm load can be engaged to help reduce signal reflections as well as to improve external noise immunity, therefore improving the overall signal transmission. A pass-through XLR line-level output is also provided to daisy-chain multiple M1.1 and A1.5 amplifiers.

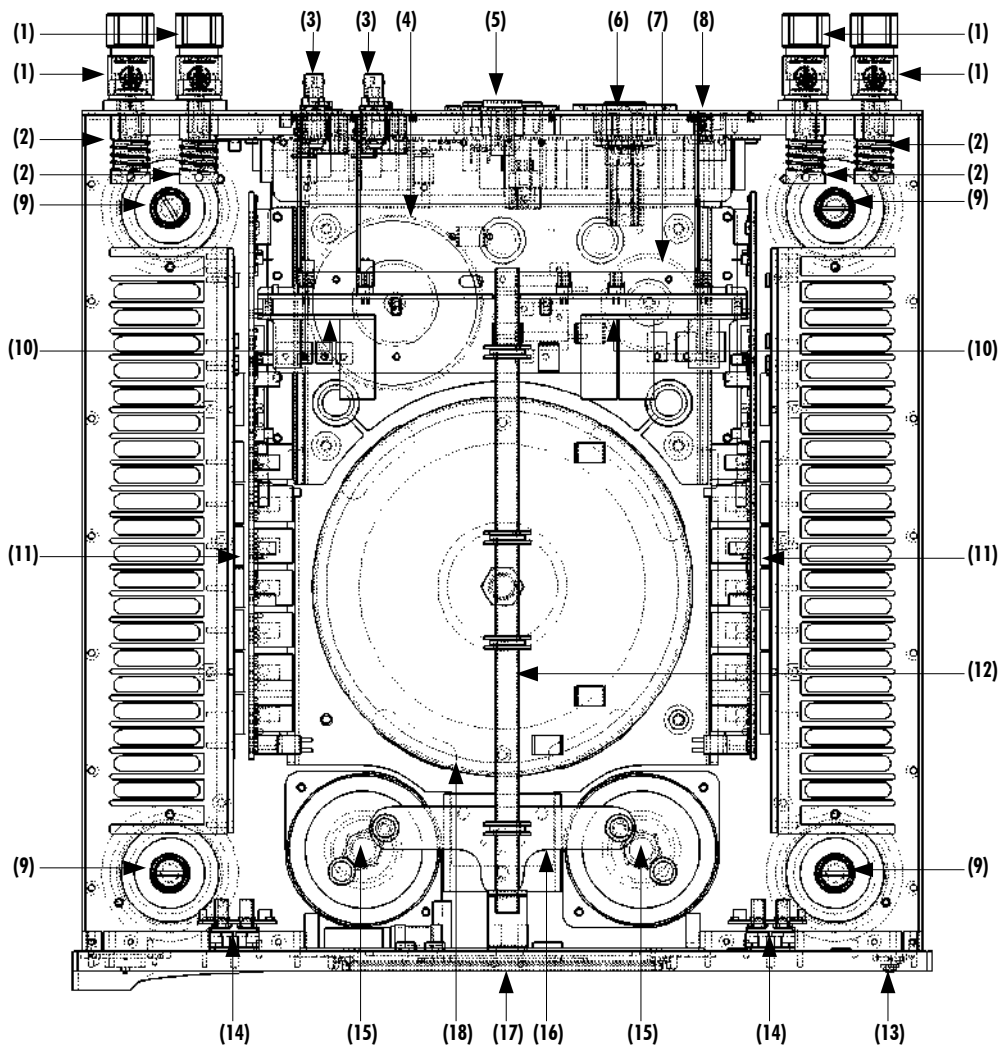

M1.1 main components



- (1) Customized Argento Audio speaker terminals
- (2) Output coil for HF immunity
- (3) Monaural analog input boards (each M1.1 can be equipped with 1 or 2 such boards)
- (4) Small signal power transformer
- (5) Mains switch, low power section fuse and power cord receptacle
- (6) High power section fuse and power cord receptacle
- (7) Standby power transformer (ensures green mode Standby)
- (8) USB (firmware update) and RJ-45 (control) board
- (9) Adjustment shafts and spikes
- (10) Power supply regulation boards
- (11) Heatsink-mounted amplifier boards
- (12) Shielded small-signal analog ground
- (13) User interface push buttons
- (14) Rectifying diode bridges, mounted onto the front panel
- (15) Custom ultra-low ESR/ESL rectifying capacitors
- (16) Main analog ground oxygen-free copper plate
- (17) Display (on front panel)
- (18) High power section transformer

1.1 Unmatched flexibility

The M1.1 offers unmatched system integration flexibility. Not only does it provide multiple modes of operation (stereo, monaural, bridge and bi-amplification modes) but also allows adjustments to match the loudspeaker impedance and sensitivity through feedback and gain controls. The operating modes can be selected from the M1.1 front panel user interface or from the Android app.

1.1.1 Operation modes

The M1.1 integrates two power amplification channels and provides the option to support a single or dual input boards. In its default configuration, the M1.1 is delivered with a single input board and provides following modes of operation:

- **Monaural mode:** In this mode, the entire power of the power transformer is dedicated to a single output channel and the M1.1 can deliver up to 2200W. It is optimal for low impedance speakers, requiring large amount of current.
- **Passive bi-amplification mode:** In this mode, the M1.1 operates its two power amplification channels, each channel driving a different loudspeaker terminal with an identical signal. Feedback and gain can be adjusted independently for each channel to best match the individual speaker sections. In Bi-Amplification Mode, each channel delivers 200 W under 8 Ohm (350W under 4 Ohm or 600W under 2 Ohm). It is optimal with speakers with more than one pair of binding posts.
- **Bridge mode:** In this mode, the M1.1 operates as a very high power monaural power amplifier, where both amplification channels are used in balanced mode from a single audio signal. When configured in Bridge Mode, the M1.1 can deliver up to 700 W under 8 Ohm. It is optimal for high impedance speakers in large rooms, requiring large voltage swings.

By adding a second input board, the M1.1 provides following additional operating modes:



- **Stereo mode:** In Stereo Mode, each amplification stage is driven by its dedicated input board and the amplifier operates as a standard stereo power amplifier. Feedback and gain settings are shared among both amplification channels and the M1.1 delivers 200 W under 8 Ohm per channel. It is the configuration used when a single M1.1 drives a pair of speakers.
- **Active bi-amplification mode:** As for Stereo Mode, Active Bi-Amp Mode links each amplification stage to its dedicated input board. Feedback and gain can however be adjusted individually for each channel in order to best match the requirements of each driver. An active cross-over is generally used to split the signal into different frequency bands between the system controller/preamplifier (such as CH Precision's L1) and the power amplifiers. In the Active Bi-Amp Mode, the M1.1 delivers 200 W under 8 Ohm on each channel. It is optimal if the speaker has an external active crossover filter network.

1.1.2 Feedback ratio control

One of the M1.1's most unique features is its user controllable feedback ratio. This feature provides control over the ratio between global and local feedback applied in the M1.1's amplification stage. Global feedback takes a portion of the output signal after the power stage and feeds it back to the input of the amplifier. This ensures a very low output impedance and low distortion figures. Local feedback, on the other hand, does not include the output stage and lets the latter operate in open loop mode. This favors small signal details and timing. As a rule of thumb, a higher ratio of global feedback is preferred for grip and control in the low frequencies whereas a lower ratio is preferred for speed and details in the high frequencies. This rule is however not absolute as each speaker and cross-over are different and we highly recommend to try out various settings to find the best match with the connected loudspeakers, especially if the M1.1 is driving a complete full bandwidth loudspeaker. In multi-amplification systems, different feedback settings are commonly used for the various speaker sections opening a whole new level of performance. We recommend to start with pure local feedback and increase the global feedback until the bass are tight enough to your personal taste. Feedback ratio settings can be adjusted on the fly from the M1.1 front panel user interface.

1.1.3 Gain control

The M1.1 provides an integrated gain control with a 24 dB range in 0.5 dB steps. It allows optimal matching of the loudspeakers sensitivity, room size, and preamplifier output level. In multi-amplification systems it can be used to match the sensitivity of the individual loudspeaker sections. Gain is conveniently accessed from the front panel user interface and can be set on the fly.

1.1.4 Bias circuitry (ExactBias)

The M1.1 provides a patent-pending advanced bias control circuitry called the ExactBias that does not only follow slow temperature variations, but also accurately takes into account all the dynamic aspects induced by transients in the musical content.

1.2 Advanced monitoring circuit

1.2.1 Power monitoring

Each power amplifier board is equipped with a DSP that monitors the instantaneous output voltage and current of each M1.1 channel. Both values are sampled at around 100 kHz, ensuring peak values are properly detected. This circuitry has several purposes: give the user a feedback of the peak power fed to the loudspeakers, and detect malfunctions such as short-circuits or amplifier damage.



1.2.2 Temperature monitoring

The DSPs also monitor both the power transistors and the heatsink temperatures. If the temperature becomes excessive, the M1.1 will protect itself by entering standby mode.

1.3 Careful construction

The M1.1 power amplifier chassis is made of high grade aluminum alloy and steel elements with no visible screws on the front, top and side panels. The front panel, side panels and top cover are machined from aluminum, while the base plate is machined from solid steel, ensuring optimal mechanical reference and magnetic shielding. First class mechanical and chemical surface treatments provide the luxury finish of the M1.1.

Pin assembly of all chassis elements enables smooth joints between metal parts while screws every 6cm ensure protection against electromagnetic interferences.

Four stainless steel feet support the unit. Each foot ends with an elastomer ring to sit on delicate surfaces but is also equipped with height adjustable hardened steel spikes to fine tune the unit position. Horizontal leveling is accomplished using the provided screwdriver through the four adjustment shafts accessible from the top of the unit. Moreover, the steel spikes serve as vibration evacuation channels for stacked units. Special covers are provided to interface with the spikes of the unit above. Any vibration from the upper unit is transmitted by the shaft cover to the shaft of the lower unit and from there to the lower unit's feet or spikes, forming a privileged path for vibrations evacuation.

The area where the air flows to cool down the amplifier is hermetically sealed from the rest of the M1.1, ensuring the electronic circuitry is protected from gradually gathering dust.

1.4 Modular architecture and slot-in boards

The M1.1 benefits from a fully modular architecture. It features separated sections for power rails, analog and digital power supplies, front panel, signal routing and central host processor, monaural analog input boards and single channel amplification boards. This modular architecture combined with the USB plug for firmware update allows for easy servicing and upgrade should one section become faulty or obsolete.

The slot-in boards section consists in a vertically mounted mother board with optional boards plugged into it. Optional boards provide audio functionality and connectivity to other equipment. There are two types of slot-in boards:

- **ANALOG_IN:** provides mono single-ended RCA and BNC (both configurable as either high impedance or 300 Ohm terminated) and balanced XLR analog audio input. One (left or right) or two (left and right) such boards can be fitted into the M1.1. By default, the M1.1 is factory delivered with a single ANALOG_IN board.
- **CONTROL:** provides a USB port for software upgrade and an Ethernet port for command. The CONTROL board is factory mounted in each M1.1.

There are three slots in the M1.1. Two of them can be populated with a left ANALOG_IN and/or a right ANALOG_IN board. The last slot is dedicated to the CONTROL board. Note that optional boards **MUST** be installed by a qualified technician. Failure to do so will void any warranty.



1.4.1 Monaural analog inputs: ANALOG_IN board

The ANALOG_IN board features a user selectable mono analog input on three different connectors: single-ended RCA, single-ended BNC and balanced XLR. Both the RCA and BNC inputs can be configured for high-impedance or 300 Ohms load. In addition to its inputs, the ANALOG_IN board includes an XLR output providing a pass-through of the input signal.

1.4.2 Firmware update and control: CONTROL board

The CONTROL board is factory installed into the M1.1. It provides a USB port for software updates using a flash drive and an Ethernet port for controlling the unit over a network.

1.5 Power supply

The power supply of the M1.1 is a linear supply with multiple independent local regulations. The high power section of the amplifier uses an oversized 2200VA magnetically shielded toroidal mains transformer. Because this section is capable of supplying up to 2200W, a dedicated mains plug (IEC C20 square plug described as “High Power Inlet” at the back of the unit) has been used to connect to the high power mains transformer.

A second toroidal transformer is used to supply power to the low power stages of the amplifier as well as to supply power to the digital areas of the amplifier (front panel display, microcontroller and DSPs that controls and supervise the unit).

The third toroidal transformer inside the M1.1 is used as the Standby transformer to ensure green Standby mode, meeting the latest energy saving regulations.

The second and third transformers are connected together to the other IEC plug.

All transformers have static shields between primaries and secondaries. They are mounted on a separate steel plate which is isolated from the main base steel plate by silent blocks to prevent vibration transmission to the rest of the unit.

Custom power capacitors are used at the rectification stage. These capacitors exhibit exceptionally low ESR and ESL, high speed and high capacitance (120'000 µF each), providing instantaneous response to peak current required by the output stage. A massive oxygen-free copper plate in between the capacitors is used as signal ground reference.

Discrete (power-transistor and opamp based) ultra low noise regulators are used throughout the power supply to ensure the purest low noise DC feed possible to the different sections. The input stages of the power section are also fully regulated to avoid any coupling distortion.

Input AC voltage to the power supply can be set to 100V, 115V or 230V AC depending on your local mains voltage.



2 Read carefully before use

Please read the following carefully.

2.1 Package content

Make sure that the package content is complete. If not, please contact your authorized dealer. Your package should contain:

- M1.1 power amplifier with one (mono bridged or mono passive bi-amp modes only) or two input boards, depending on the ordered configuration
- A power cord
- Four adjustment steel spikes
- A suction cup (used to unscrew the top covers)
- An accessory box containing:
 - a spike adjustment screwdriver
 - a Torx T10 screwdriver
 - four stacking covers
 - a USB stick containing the latest CH Precision firmwares.
 - a set of four CH Support Discs

Please store the packaging material for future use. Check your M1.1 power amplifier for any apparent damage. In case of damage, please contact your authorized dealer. If your M1.1 power amplifier is still very cold from transport, please let it warm up to room temperature in order to avoid condensation inside the unit.

2.2 Safety notice

Make sure to observe the following rules:

- Install your M1.1 power amplifier on a stable base
- Do not install your M1.1 power amplifier near water
- Always handle with care. The M1.1 power amplifier is very heavy so have someone to help you when moving it around
- Do not expose the unit to any kind of liquids
- Do not install it under direct sunlight or near any heat source such as radiators or other apparatus generating heat



- Do not install it in a confined space and make sure there is sufficient airflow around the unit, including under the unit.
- Never install your M1.1 power amplifier directly on a carpet or any soft material, as it would block the air vents and prevent adequate airflow.
- Do not operate under high ambient temperature ($>40^{\circ}\text{C}$) or in extremely high humidity conditions
- Only use options and accessories specified or recommended by the manufacturer
- Do not open the unit nor try to service it by yourself. Always refer to a qualified technician for service, maintenance or upgrades. Failure to do so will void the unit's warranty

2.3 User manual

Please read this manual carefully before making connections or operating your M1.1 power amplifier. After reading this manual, please store it in an accessible place for future reference. If, after reading this manual, you feel unsure about how to make connections or how to operate the unit, please contact your authorized dealer for assistance.

2.4 Mains supply

In order to use the amplifier to its full capabilities, the M1.1 needs two independent mains phases to be connected to the back panel. The power section being able to deliver up to 2200W, it is on the edge of exceeding the maximum current a traditional mains phase is able to deliver before the circuit breaker trips. With the addition of the power needed by the rest of the amplifier (second and third transformer sections), the maximum current could be exceeded and the circuit breaker would trip. It is therefore recommended to use two separate mains phases to ensure that in no circumstances will the circuit breakers trip.

Before connecting any mains power cord, make sure that the mains voltage selection at the back of the unit matches your local mains voltage.

Make sure your M1.1 power amplifier is disconnected from the AC wall socket in the following cases:

- When making connections (it is also recommended to disconnect the rest of the system from the AC wall socket)
- When cleaning the unit
- During thunderstorms
- When unused for a long period of time

2.5 Transport and packaging

The M1.1 power amplifier must always be stored in its original packaging during transport. Doing so will ensure an optimal level of protection of your unit. Therefore, keep all packaging in a dry and clean place for future use.

Finally we recommend to remove the adjustment spikes and to put them back in the foam holes of the M1.1 box during transport. Vibrations during transport may cause the adjustment spikes to move from their fully retracted position. There is risk of scratching



the installation base if the spikes are not fully retracted when installing the unit.

2.6 Cleaning

Use a soft, dry cloth for cleaning the casing of the unit. Never use any solvent or liquids as they may damage the surface or infiltrate the unit.

Use ultra-soft lense cleaning cloth to clean the display window. This fabric can be wet with ethanol if greasy fingerprint needs to be removed.

2.7 Maintenance and service

The M1.1 power amplifier contains no user serviceable parts. Do not try to open, modify or repair your M1.1 by yourself. This will void any warranty. Your M1.1 power amplifier must be checked by a qualified technician in any of the following cases:

- The unit is not functioning properly
- The power cords or mains plug at the back of the unit is damaged
- The unit was dropped to the floor or presents external damages
- The M1.1 power amplifier has been exposed to liquids or unknown substances



3 Installation

3.1 Unpacking

Unpack the M1.1 power amplifier and store the packaging for future use. At least two people are required to lift the M1.1 as it is very heavy (over 75kg).

3.2 Positioning your unit

We recommend to locate the M1.1 close to the loudspeaker it drives, using short loudspeaker cables.

For best transmission and immunity to external noise, we recommend to connect the M1.1 input to the upstream unit (preamplifier) using a balanced XLR cable.

When delivered from factory, the M1.1 amplifier's four feet sit on elastomer rings, ensuring both scratch-protection for the base on which the unit sits, as well as safe anti-slipping unit positioning.

But a more advanced vibration-channeling mechanical coupling can be implemented, thanks to the steel spikes and the polymer support discs provided with the M1.1. To use this optimal coupling, simply go through the following steps:

1. Place the M1.1 unit on a stable base at its approximate final position, for instance in your preferred audio rack. Make sure cooling air is able to freely flow around the unit.
2. Gently lift the unit's corners and insert a support disc under each foot. The foot's elastomer ring should disappear in the support disc's groove when properly placed. Carefully check all four feet perfectly fit in each support disc before pursuing any further. The unit should stably rest on its feet at that point.
3. Unscrew the four top covers from the M1.1's shafts with the provided suction cup. Be careful not to scratch their delicate finish.
4. Insert the adjustment spikes into each adjustment shaft.
5. Softly screw clockwise each adjustment spikes into the shaft with the provided screwdriver, until any resistance is felt (just before the unit's corner starts to lift).
6. Then screw clockwise each spike by the same amount (for instance two full turns).
7. If the base is flat, the unit should be stable and horizontal. If not, correct the unit's stability and horizontality by turning clockwise or anti-clockwise the required spikes.
8. If no CH Precision unit is to be stacked on top of the M1.1, screw the four top covers back. Otherwise, screw the four polymer stacking caps instead, and gently lay down the unit to be stacked on top of it. Be very careful that both units are perfectly aligned in order not to scratch the M1.1's top plate with the other unit's feet. Repeat steps 3 to 8.

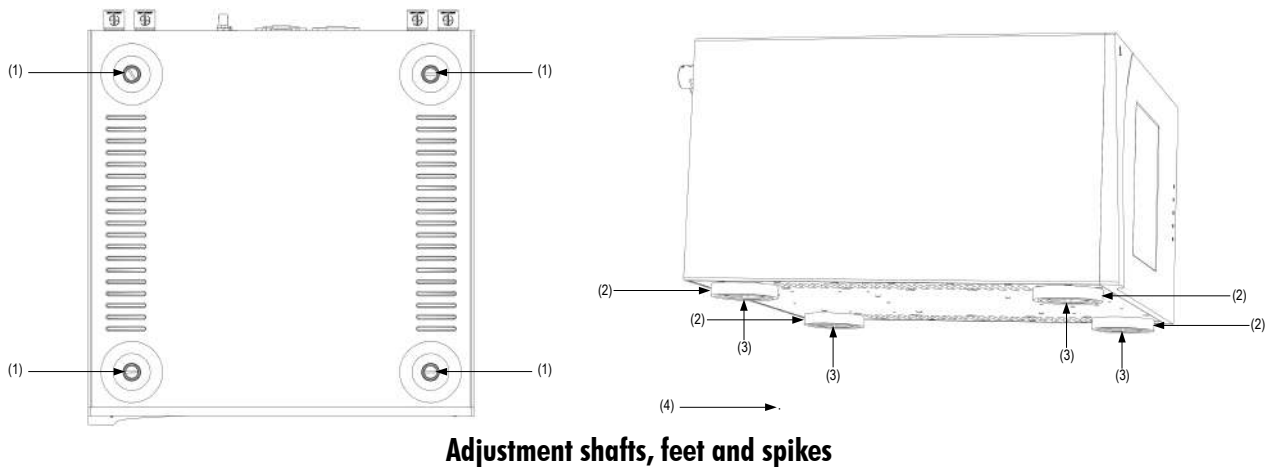

- (1) Adjustment shafts. Insert the adjustment spikes and use the provided screwdriver to secure and adjust individual spikes
- (2) Feet
- (3) Adjustment spike heads (when inserted into adjustment shafts)
- (4) Adjustment spike

Never stack any component other than CH's on your MI.1. Never use the aluminum shaft covers (top covers) when another CH component is to be stacked on top of your MI.1.

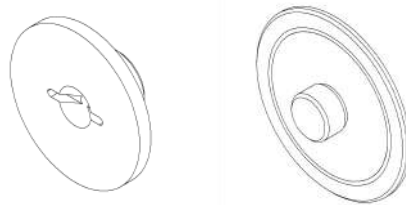

Shaft covers (left: stacking cover, right: top cover)

3.3 Connections

This section provides information about how to connect your MI.1 power amplifier to your system. For details about how to integrate your MI.1 in a specific setup, please refer to the Amplifier modes section of this user manual. If you don't feel confident with the connections to be applied, please contact your authorized dealer for assistance.

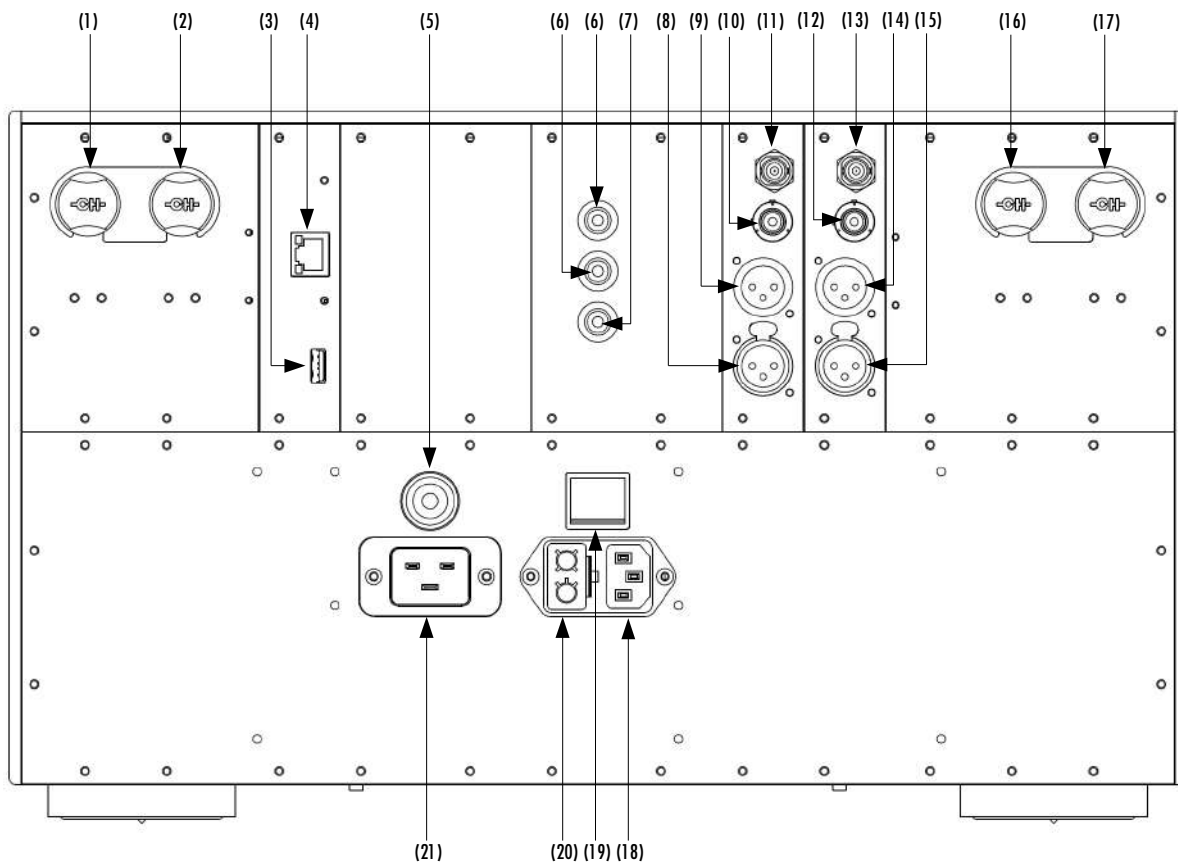

M1.1 rear panel connections

- (1) Right channel negative loudspeaker terminal (customized Argento Audio connector)
- (2) Right channel positive (or bridged mono positive) loudspeaker terminal (customized Argento Audio connector)
- (3) USB port for software upgrades [CONTROL board]
- (4) Ethernet port for network remote control [CONTROL board]
- (5) High power section fuse (16A for 230V mains, 32A for 100V and 115V mains)
- (6) Analog ground connectors. The bottom one can be connected to digital ground (Earth) using the provided jumper
- (7) Earth connector. Internally connected to digital ground
- (8) Right channel XLR balanced analog input
- (9) Right channel XLR balanced analog output (pass-through for amplifier daisy-chaining)
- (10) Right channel RCA single-ended analog input
- (11) Right channel BNC single-ended analog input
- (12) Left channel RCA single-ended analog input
- (13) Left channel BNC single-ended analog input
- (14) Left channel XLR balanced analog output (pass-through for amplifier daisy-chaining)
- (15) Left channel XLR balanced analog input
- (16) Left channel positive (or bridge mono negative) loudspeaker terminal (customized Argento Audio connector)
- (17) Left channel negative loudspeaker terminal (customized Argento Audio connector)
- (18) Low power section power cord receptacle
- (19) Mains power On/Off switch
- (20) Low power section fuses (1.6A + 250mA for 230V mains, 3.15A + 500mA for 100V and 115V mains) and voltage selection
- (21) High power section power cord receptacle

3.3.1 CONTROL board

The CONTROL board provides a USB port for software upgrades and an Ethernet port for controlling the unit over a network. The following drawing shows the layout of the CONTROL board back panel:

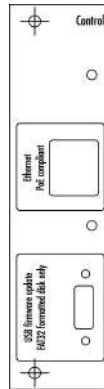

CONTROL board back panel layout

3.3.1.1 USB port

The USB port on the CONTROL board is dedicated to upgrading the firmware of the M1.1 unit. Do not use it for any other purposes. For more information on unit firmware update, please refer to the relevant section in this manual.

3.3.1.2 Ethernet port

The Ethernet port allows the control of the M1.1 amplifier settings through a standard Ethernet network. Connect the M1.1 Ethernet port to an Ethernet Router or Switch using an Ethernet RJ45 Category 5 or better. Using the CH Android App, the M1.1 settings can be accessed and adjusted on the fly via a tablet.

3.3.2 ANALOG IN board

The ANALOG IN board features a user selectable analog input on three different connectors: balanced XLR, single-ended RCA and single-ended BNC. The analog stage design is fully discrete and balanced. Both the RCA and BNC inputs can be configured for high-impedance or 300 Ohms load. The latter helps to reduce signal reflections as well as to improve external noise immunity, therefore improving the overall signal transmission. In addition to the inputs, the ANALOG IN board includes an XLR output creating an input signal pass-through. This output can be used to daisy-chain multiple M1s (and A1s) in multi-amplification systems for ultimate performances. Balanced connections are recommended for optimal performance. The Following drawing shows the layout of the connectors on the ANALOG IN board.

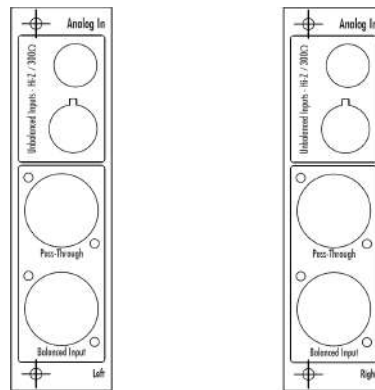

ANALOG IN panel layout

3.3.3 Power cord receptacles and voltage selection

Make sure that the voltage selection is set to the correct value with respect to the AC voltage in your location. Connect the power cords to the power cord receptacles and plug the power plug to two separate phase AC wall sockets, only after all other connections have been made.

3.4 Amplifier modes

This section describes most standard setups in which one or multiple M1s can be integrated into.

3.4.1 Stereo mode

A single M1.1 equipped with two analog input boards can be used as a stereo power amplifier. This is the simplest configuration that already allows to enjoy the unique sound of the M1.1 amplifier. The picture below shows how it should be connected in this case.

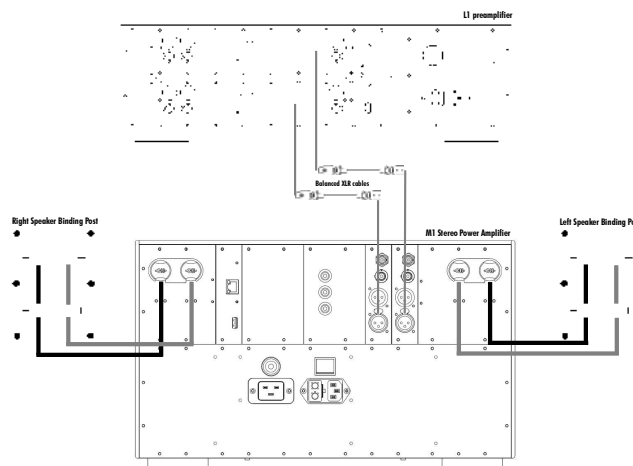

Stereo mode

3.4.2 Monaural mode

This configuration should be used when low efficiency low impedance loudspeakers are used in large rooms. The picture below shows how a pair of M1s should be connected in this mode:

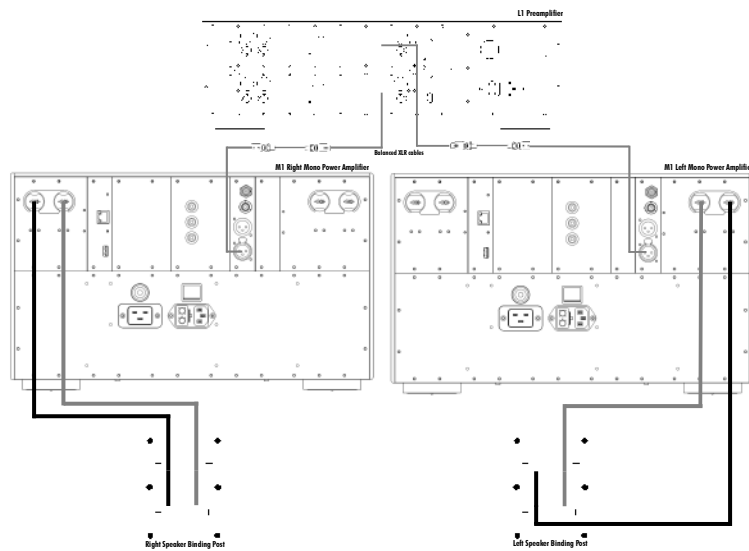

Monaural mode

3.4.3 Bridge mode

This configuration should be used when low efficiency high impedance loudspeakers are used in large rooms. This configuration also exhibits a better signal-to-noise ratio. The picture below shows how a pair of M1s should be connected in this mode:

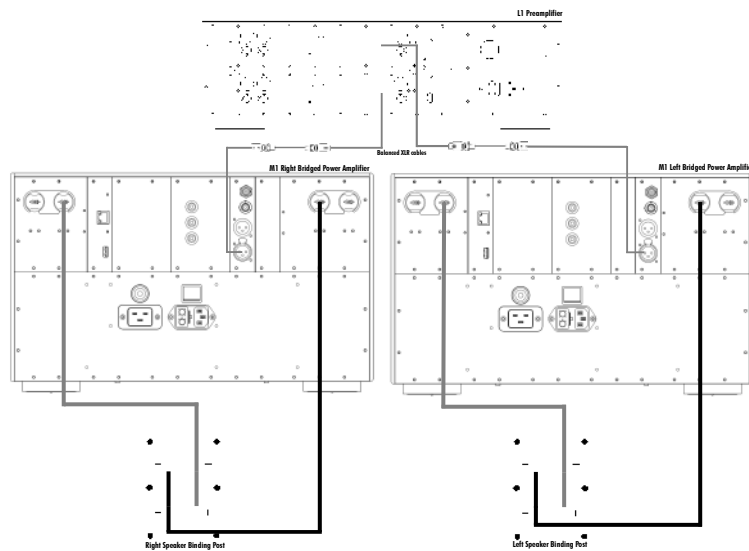

Bridge mode

3.4.4 Passive bi-amplification mode

In this mode, each M1.1 operates its two power amplification channels in parallel, each channel driving a different loudspeaker terminal from an identical signal. Feedback and gain can be adjusted independently for each channel to best match the individual speaker sections. The picture below shows how the M1s should be connected in this mode:

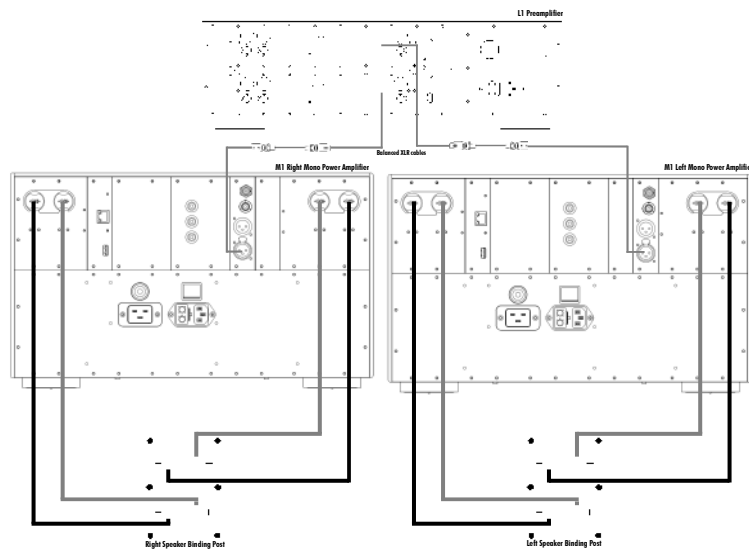

Passive bi-amplification mode

3.4.5 Active bi-amplification mode

A pair of M1s, each with two analog input boards installed, can be used in active bi-amplification mode. In such a case, each output board of each M1.1 feeds the speaker's drivers of a given frequency range. This configuration is optimal when an active crossover network is used. Optimal global/local feedback ratio can be set for the different frequency bands. The picture below shows how they should be connected in this case.

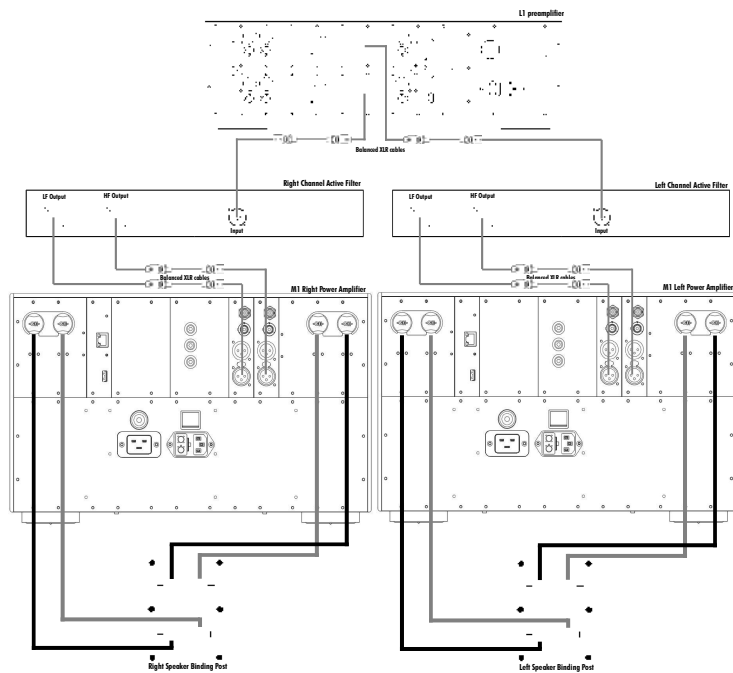

Active bi-amplification mode



3.4.6 Daisy-chain mode

When more than one M1.1 is used to drive a single loudspeaker, they can be daisy-chained. This allows for ultimate configuration taking advantage of the increased power available in Bridge mode as well as the flexibility coming with multi-amplification systems (optimal feedback ratio setting for each frequency band). The picture below shows an example of such a daisy-chain configuration, namely passive bi-amplified bridge mode.

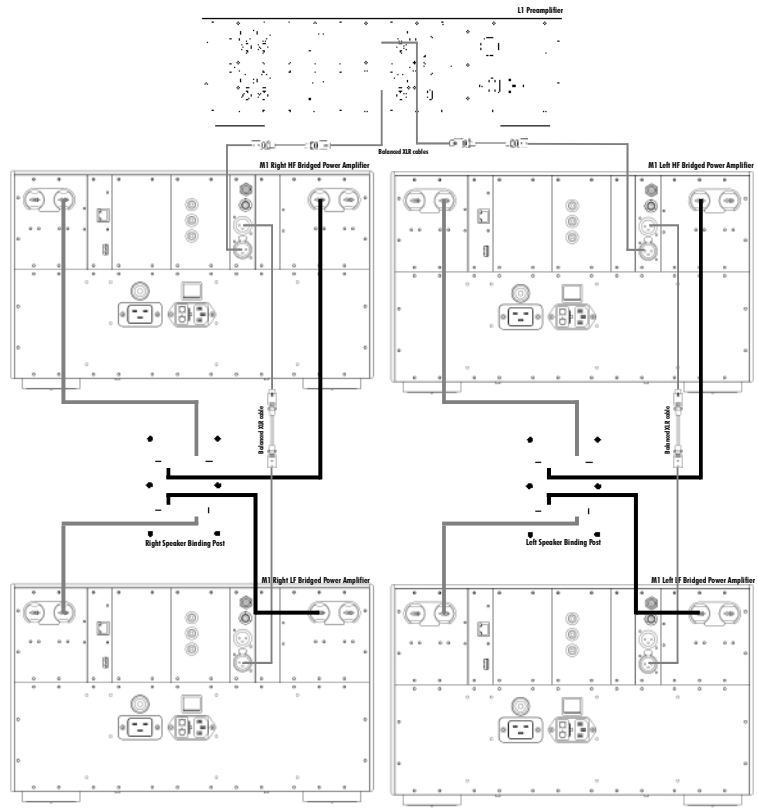

Passive bi-amplified bridge mode (daisy-chain mode)

4 Operation

The M1.1 Monaural power amplifier is operated either from the unit's front panel display and push buttons or from the CH Precision Android App available on tablets. The tablet reflects the state of the unit settings and allows the user to adjust the settings on the fly.

4.1 Front panel controls

4.1.1 Front panel

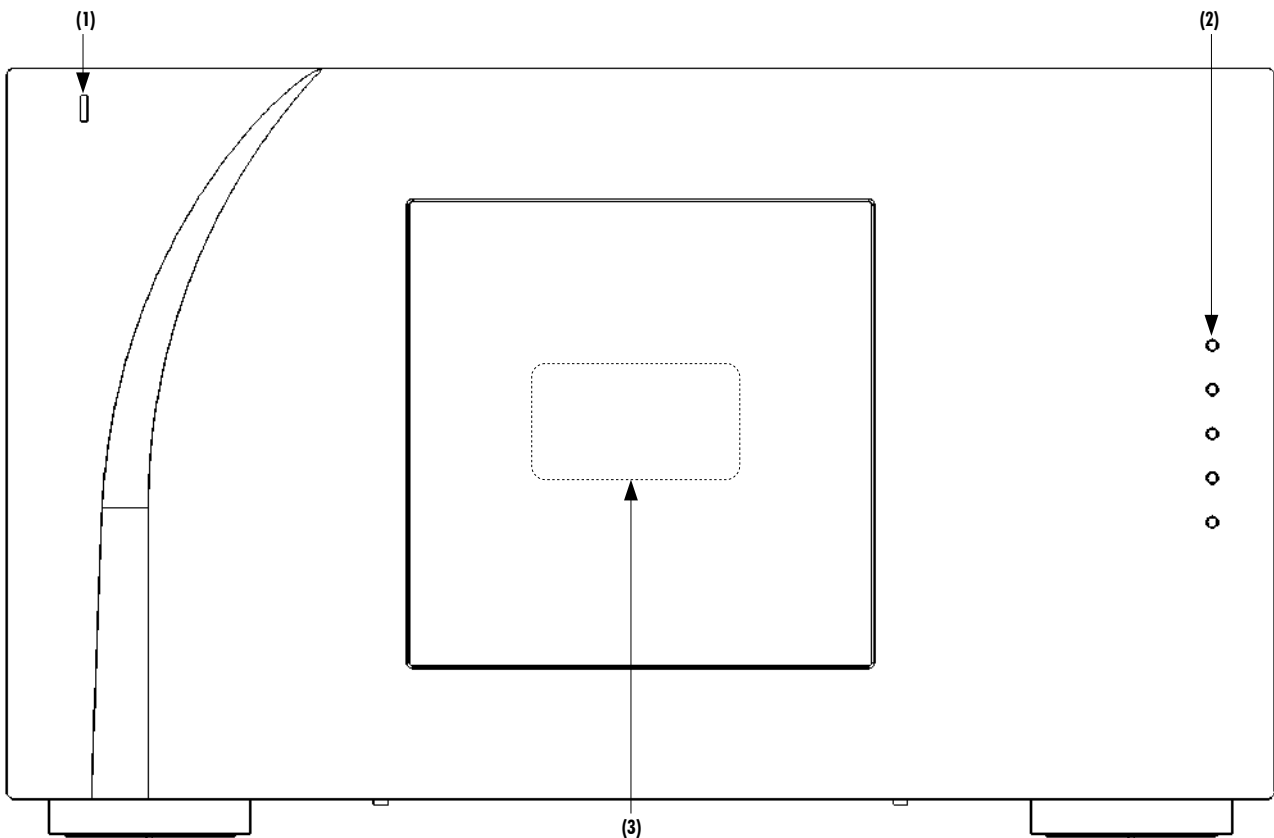

Front panel elements

- (1) Standby LED
- (2) Five user control push buttons
- (3) Display area (high-definition display)

The standby LED lights up when the unit is in standby. It is normally turned off during operation. The LED can also be programmed to remain on during operation. The display is a user customizable colors high-definition panel with very wide viewing angle, high contrast and high brightness ensuring optimal reading comfort. The color and brightness of the display can be configured according to the user's taste.

4.1.2 Front panel push buttons

The push buttons located on the front panel of the M1.1 are the user input devices.

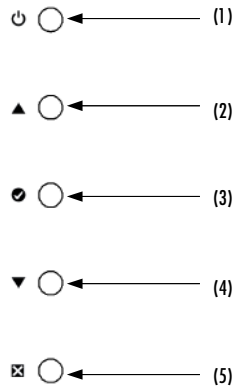

Front panel push buttons

Button number	Button symbol	Description
1	⏻	Standby (long push) / Mute/Unmute (short push)
2	▲	Up
3	⊗	OK
4	▼	Down
5	⊠	Cancel

Front panel push buttons description

4.2 Operating modes

The M1.1 monaural power amplifier has two main operating modes: Normal mode and Menu mode. Normal mode is mainly used to display the M1.1 general status (such as power or temperature) whereas the Menu mode is used to configure the unit. The M1.1 also includes Shortcuts to quickly access preselected Menu items. Shortcuts are user programmable and most Menu mode items can be selected as Shortcuts.

4.2.1 Normal mode

In normal mode, the M1.1 can be configured to display its general status, such as operating mode (stereo/mono), input (XLR/BNC/RCA), feedback ratio, peak power and internal temperature. It can also be set to display a peak power VU-meter, or a temperature gauge for each output channel. Once powered-on, the M1.1 sits in Normal mode. The status display looks as follows:

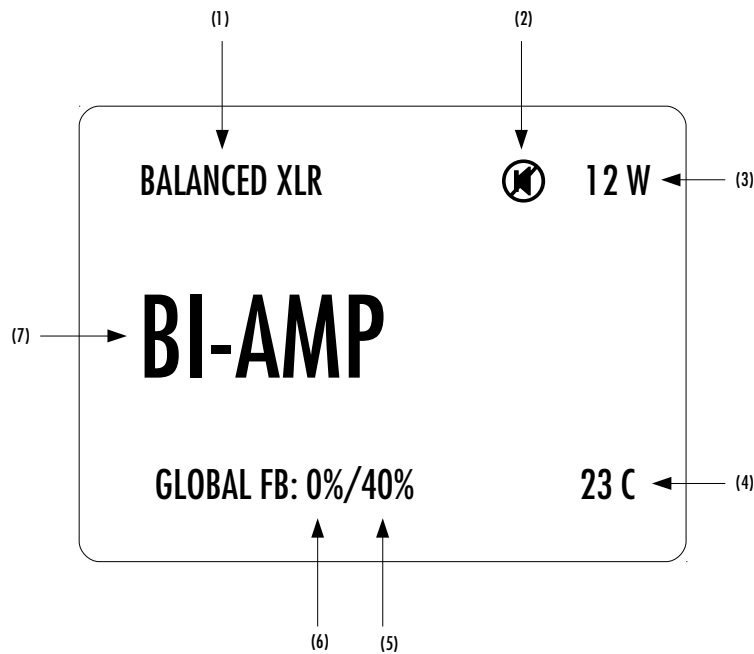

Normal mode display elements

- (1) The input selected as well as the impedance termination setting.
- (2) Mute indication. If the symbol is present, the output is muted
- (3) Instantaneous power indication. Gives a reading of the peak power (in Watts) supplied to the loudspeaker. Except for bridge mode, the highest peak power among the two channels of the M1.1 is displayed
- (4) Average temperature of the two output channels (in degree Celsius).
- (5) Global feedback applied to the channel 2 output board (only displayed in bi-amplification mode)
- (6) Global feedback applied to the channel 1 output board (in Bi-amplification mode) or to both output boards (in Monaural or Bridge mode)
- (7) Amplifier mode (Monaural, Bi-amplification or Bridge)

Displayed elements depend on the user settings. In the example above, the M1.1 is set as a bi-amplifying power amplifier, using the balanced XLR connector as input, with its outputs muted (in that example the power should actually display 0 W). Its internal temperature is 23°C. The output channel 1 is set to 0% global feedback (100% local feedback), while the output channel 2 is applying a mix of 40% of global feedback (therefore 60% of local feedback).

The following table shows the actions of the front panel push buttons in Normal mode.

Front face push buttons	Unit State	Unit Action
, short push	STANDBY Any other state	Wakes up from STANDBY Mutes/Unmutes outputs
, long push	STANDBY Any other state	Wakes up from STANDBY Goes to STANDBY
	Any state	Enters Shortcuts mode
	Any state	Enters Shortcuts mode



▼	Any state	Enters Shortcuts mode
⊗	Any state	No effect

Push buttons actions in Normal mode

4.2.2 Shortcuts

The M1.1 amplifier settings are accessible through a set of menus as described in the next sections. However, to allow quick access to the most frequently used configuration menu items, the M1.1 offers the concept of Shortcuts. Shortcuts are fully programmable and the user may choose any configuration parameter as a Shortcut. There are up to 6 user programmable Shortcuts. To learn how to program individual Shortcuts, please refer to the SHORTCUTS menu item in the next section. There is no shortcut defined within the Factory default settings.

Shortcuts are accessed from Normal mode by pushing the OK [●], UP [▲] or DOWN [▼] buttons on the front face. Additional OK [●] pushes toggle through the Shortcut list. The last Shortcut is always dedicated to entering the Menu mode (SETUP). On this last Shortcut, an OK [●] push will return to Normal Mode while an UP [▲] push will enter the Menu mode. The individual parameter for a given Shortcut is modified using UP [▲] or DOWN [▼] buttons. The unit will revert to Normal mode if no action is taken for about 10 seconds.

The following table shows the actions of the push buttons for the Shortcuts.

Front panel push buttons	Unit State	Unit Action
STANDBY [⏻] Short Push	Any state	Mutes/Unmutes unit
STANDBY [⏻] Long Push	Any state	Goes to STANDBY
UP [▲]	Shortcuts (except last) Last Shortcut (SETUP)	Modifies parameter up (when available) No action
OK [●]	Shortcut (except last) Last Shortcut (SETUP) or after current Shortcut has been modified	Skips to next Shortcut Confirms the new selection and exits Shortcuts mode (Normal mode)
DOWN [▼]	Shortcuts (except last) Last Shortcut (SETUP)	Modifies parameter down (when available) Enters Menu mode
CANCEL [⊗]	Shortcuts	Exits Shortcuts mode (Normal mode)

Push buttons actions for the Shortcuts

The GAIN Shortcut gives a good illustration of how to navigate a Shortcut screen. The navigation in other Shortcuts is similar.

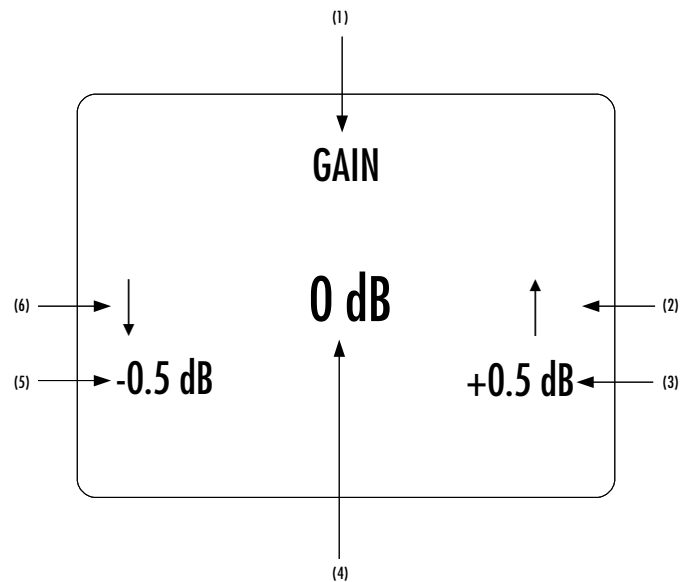

GAIN Shortcut screen

- (1) Shortcut title (Parameter being adjusted, for other Shortcuts, title changes accordingly)
- (2) Arrow referring to the UP button [▲]. The item below indicates the next value (Up direction)
- (3) Next Parameter Value if UP button [▲] is pushed (parameter up)
- (4) Current Parameter Value
- (5) Next Parameter Value if DOWN button [▼] is pushed (parameter down)
- (6) Arrow referring to the DOWN button [▼]. The item below indicates the previous value (down direction)

The last Shortcut (SETUP) is always the same and cannot be removed or altered. It gives access the Menu mode and the detailed setup of the unit.

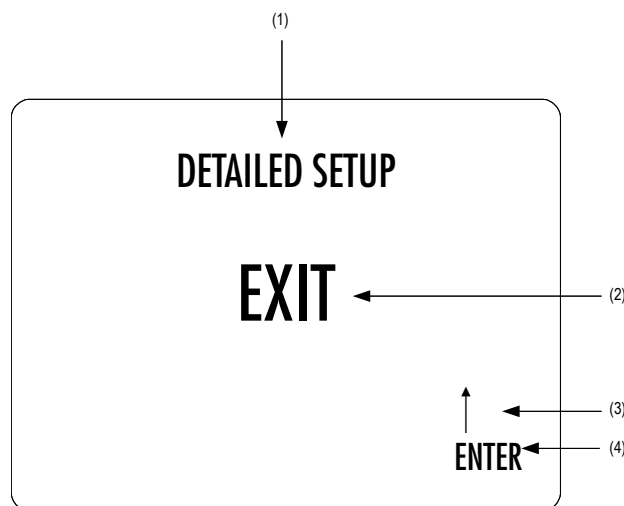

DETAILED SETUP Shortcut screen

- (1) Shortcut title. It indicates that Detailed Setup (Menu mode) can be entered at this stage
- (2) Current value of the parameter. Default action is to exit (go back to Normal mode)
- (3) Arrow indicating the UP button [▲]
- (4) Next parameter value. If the UP button [▲] is pushed, the unit enters into Menu mode

4.2.3 Menu mode

The Menu mode allows the Configuration and Setup of the M1.1 power amplifier through a set of menus. Menu mode is entered from the last Shortcut item (see above). From the Normal mode, enter the Shortcut mode by pushing the OK [●] button. By successive OK [●] button pushes, step to the last Shortcut item (DETAILED SETUP) and push the TOP [▲] button once to enter the Menu mode.

Navigation in the Menu mode is based on UP [▲] and DOWN [▼] buttons to select an item or to change a value. The OK [●] button is used to validate and CANCEL [⌫] to exit without saving.

M1.1 Front panel push buttons	Unit Action
STANDBY [⏻] Short Push	Mutes/Unmutes the unit
STANDBY [⏻] Long Push	Goes to STANDBY
UP [▲]	Moves to the next menu item upward
OK [●]	Enter the next menu level or Validate a choice (save settings)
DOWN [▼]	Moves to the next menu item downward
CANCEL [⌫]	Returns to the previous menu level without saving

Push button actions in Menu mode

The following illustration shows the items of the M1.1 SETUP Menu page.

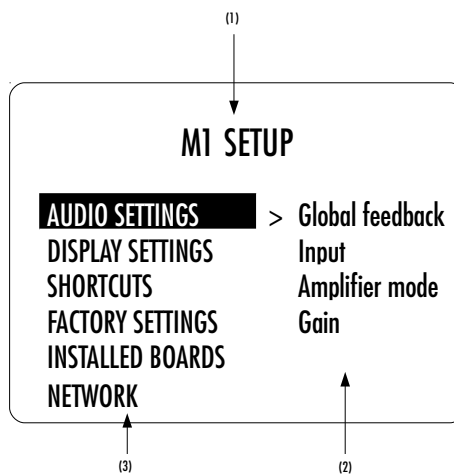

M1.1 SETUP screen items

- (1) Menu title. When entering a menu item, the title also shows the parent menu. If the AUDIO SETTINGS menu is entered, the title line would display M1.1 SETUP >> AUDIO SETTINGS.
- (2) Shows the available parameters when entering the currently highlighted menu item. In this example, AUDIO SETTINGS is highlighted and the second column shows the parameters available in the AUDIO SETTINGS menu.
- (3) The list of items in the current menu. Navigate from one item to the other by pushing the UP [▲] and DOWN [▼] buttons. To enter the highlighted menu item, push the OK [●] button. To return to the previous menu level push the CANCEL [⌫] button. In this example, the CANCEL [⌫] button would exit the Menu mode and set the unit back to Normal mode.

Once a menu item is selected by a push of the OK [●] button, parameters for the corresponding menu item can be accessed. As an example, the following drawing shows the display elements of the M1.1 SETUP >> AUDIO SETTINGS sub-menu.

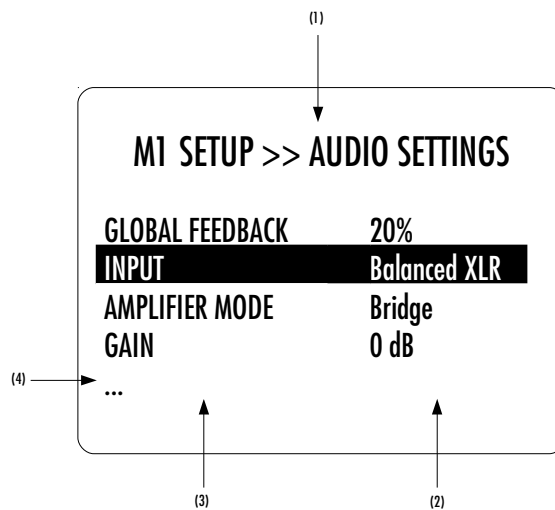

M1.1 SETUP >> AUDIO SETTINGS menu items

- (1) Menu title. M1 SETUP >> AUDIO SETTINGS shows that the parent menu is M1.1 SETUP. By pushing the CANCEL [⌫] button, the unit returns to the parent menu.
- (2) This is the Parameter Value column. For each item in the Parameter column, the Parameter Value item on the same line indicates the current value of the Parameter.
- (3) This is the Parameter column. The currently active Parameter is highlighted. Use the UP [▲] and DOWN [▼] buttons to navigate from Parameter to Parameter, and the OK [●] button to enter the edition mode of that parameter.
- (4) If the first or last item in the Parameter column is indicated by '...' it means that there are additional Parameters not displayed currently on-screen. Use the UP [▲] and DOWN [▼] buttons to navigate towards the '...' to make the corresponding Parameters appear on screen.

Once a Parameter (e.g. a Parameter not giving access to a further sub-menu) is selected by pushing the OK [●] button, the M1.1 displays the corresponding Parameter adjustment screen. The following example shows the AUDIO SETTINGS >> AMPLIFIER MODE Parameter adjustment screen. Once a Parameter is set to the desired value, an OK [●] button push saves the new Parameter Value and gets back to the parent level (saves and exits). On the other hand, a CANCEL [⌫] button push gets back to the parent menu (in the case of this example: AUDIO SETTINGS), but possible modifications of the Parameter Value are discarded (exits without saving).

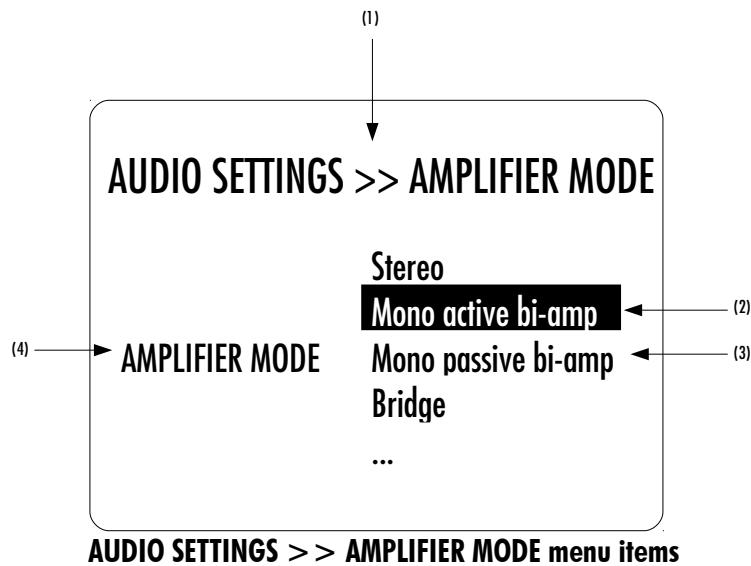

- (1) Menu title. AUDIO SETTINGS >> AMPLIFIER MODE shows that the parent menu is AUDIO SETTINGS. To access the parent menu, push the CANCEL [⌫] button
- (2) The current Parameter Value is highlighted. Push the UP [▲] or DOWN [▼] buttons to navigate through the Parameter Values
- (3) Other Parameter Value.
- (4) Parameter to be modified

The following section gives detailed information about the menu structure and the various Parameters. Note that certain Parameters may or may not appear in the menu depending on installed options. For instance if only a single ANALOG_IN board is installed or an amplifier mode requiring two input boards is selected, CHANNEL selection menu items (to select the left or right input board) will be hidden.

4.3 Configuration

Configuration of your M1.1 amplifier is accomplished by setting up parameters in the Menu mode (see previous section on how to access the Menu mode and how to navigate through menu items). The following diagram shows the complete menu structure (final items not shown).

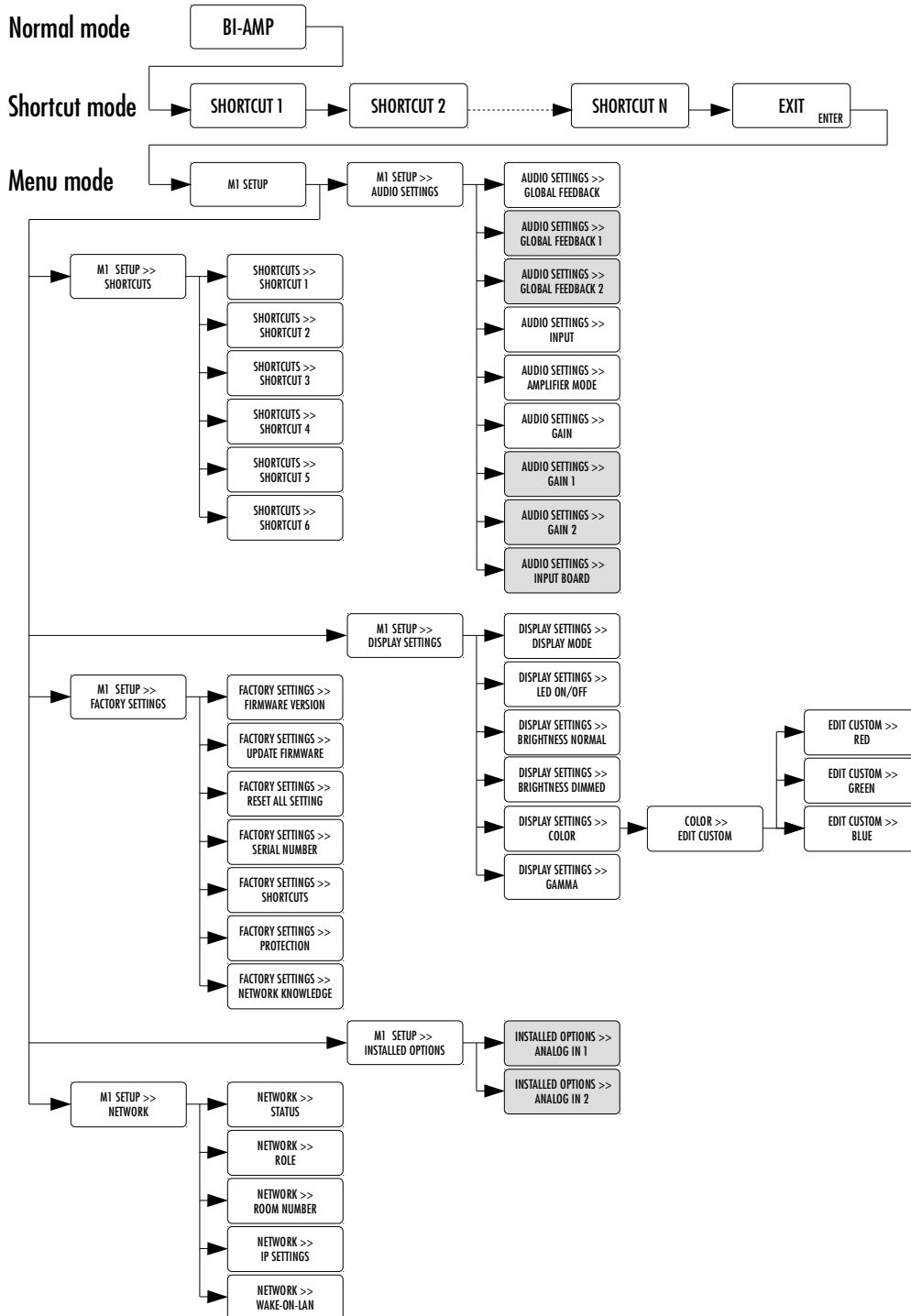

M1.1 Amplifier menu structure



There are five main menus used to configure the M1.1:

- **AUDIO SETTINGS:** Allows to adjust audio related parameters
- **DISPLAY SETTINGS:** Allows to adjust display related parameters
- **SHORTCUTS:** Allows to assign and modify Shortcuts for user interface customization
- **FACTORY SETTINGS:** Indicates the software version and allows to update it. Also allows to return to the factory default settings
- **INSTALLED BOARDS:** indicates what audio channel the amplifier refers to.
- **NETWORK:** Provides information about the network setup and enables its configuration

4.3.1 M1.1 configuration menu items

4.3.1.1 AUDIO SETTINGS

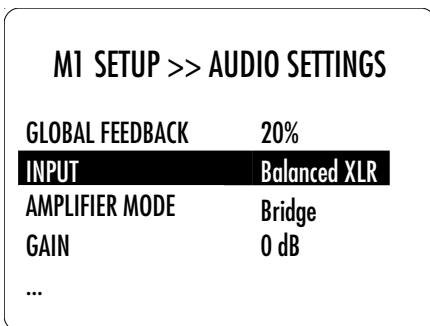

The M1.1 SETUP >> AUDIO SETTINGS menu allows the configuration of the audio related Parameters of the unit. Accessible Parameters are:

- **GLOBAL FEEDBACK:** Sets the amount of global feedback for output channels
- **GLOBAL FEEDBACK 1:** Sets the amount of global feedback for the channel 1
- **GLOBAL FEEDBACK 2:** Sets the amount of global feedback for the channel 2
- **INPUT:** Selects an input connector and impedance termination
- **AMPLIFIER MODE:** Selects in which mode the amplifier works (stereo/mono)
- **GAIN:** Adjusts the gain for both channels
- **GAIN 1:** Adjusts the gain for the output channel 1
- **GAIN 2:** Adjusts the gain for the output channel 2
- **INPUT BOARD:** Selects which input board should be used

The following table details the Parameters of the AUDIO SETTINGS menu:

PARAMETER	PARAMETER VALUES	REMARKS
GLOBAL FEEDBACK	0, 10, 20, ..., 80, 90, 100%	Monaural or Bridge modes only
GLOBAL FEEDBACK 1 / GLOBAL FEEDBACK 2	0, 10, 20, ..., 80, 90, 100%	Bi-amplification mode only
INPUT	Balanced XLR Hi-Z BNC 300 Ohm BNC Hi-Z RCA 300 Ohm RCA Hi-Z	None
AMPLIFIER MODE	Stereo	2 input boards



	Mono active bi-amp Mono passive bi-amp Bridge Monaural 1 Monaural 2	2 input boards None None None None
GAIN	24 dB range by 0.5 dB steps	Stereo or bridged mode
GAIN 1 / GAIN 2	24 dB range by 0.5 dB steps	Bi-amp mode
INPUT BOARD	Left, Right	2 input boards + passive bi-amp or bridged mode

Details of the AUDIO SETTINGS menu

4.3.1.2 DISPLAY SETTINGS

M1 SETUP >> DISPLAY SETTINGS	
DISPLAY MODE	Status
LED ON/OFF	Off
BRIGHTNESS NORMAL	80%
BRIGHTNESS DIMMED	20 %
...	

The M1.1 SETUP >> DISPLAY SETTINGS menu allows configuration of the display related Parameters of the unit. Accessible Parameters are:

- DISPLAY MODE: Selects what is displayed in normal mode
- LED ON/OFF: Selects if the LED is turned on
- BRIGHTNESS NORMAL: Sets the normal display brightness
- BRIGHTNESS DIMMED: Sets the dimmed display brightness
- COLOR: Selects the display color
- GAMMA: Fine tunes the AMOLED's display RGB gamma curve

The following table details the Parameters of the DISPLAY SETTINGS menu:

PARAMETER	PARAMETER VALUES	REMARKS
DISPLAY MODE	Status Power Temperature Off	None
LED ON/OFF	On Off	None
BRIGHTNESS NORMAL	10% 20% 30% ... 90% 100%	None
BRIGHTNESS DIMMED	10% 20%	None



	30%	
COLOR	Predefined colors Custom color Edit custom color	None
GAMMA	RGB and global brightness gamma curve correction, +/-30%	None

Details of DISPLAY SETTINGS menu Parameters

4.3.1.3 SHORTCUTS

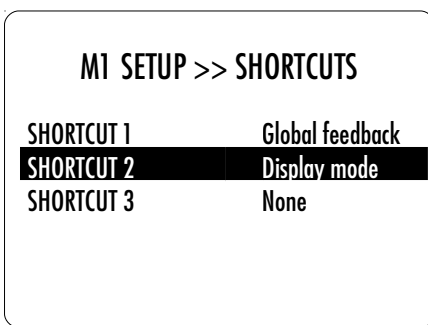

The MI.1 SETUP >> SHORTCUTS menu allows configuration of the Shortcuts.

Accessible Parameters are:

- SHORTCUT1: Defines action for Shortcut #1
- SHORTCUT2: Defines action for Shortcut #2
- SHORTCUT3: Defines action for Shortcut #3
- SHORTCUT4: Defines action for Shortcut #4
- SHORTCUT5: Defines action for Shortcut #5
- SHORTCUT6: Defines action for Shortcut #6

Note that unused Shortcuts are not displayed. The first available (e.g. non defined) Shortcut has a Parameter Value of 'None' (the example on the left has 2 defined Shortcuts, hence Shortcut #3 has a Parameter Value of 'None')

The following table details the Parameters of the SHORTCUTS menu:

PARAMETER	PARAMETER VALUES	REMARKS
SHORTCUT 1	Any Parameter of the AUDIO SETTINGS and DISPLAY SETTINGS menus or None	If SHORTCUT 1 is not defined, Parameter value for SHORTCUT 1 is set to 'None'. SHORTCUT 2 to 6 are not displayed in this case.
SHORTCUT 2	Any Parameter of the AUDIO SETTINGS and DISPLAY SETTINGS menus or None	If SHORTCUT 2 is not defined, Parameter value for SHORTCUT 2 is set to 'None'. SHORTCUT 3 to 6 are not displayed in this case.
SHORTCUT 3	Any Parameter of the AUDIO SETTINGS and DISPLAY SETTINGS menus or None	If SHORTCUT 3 is not defined, Parameter value for SHORTCUT 3 is set to 'None'. SHORTCUT 4 to 6 are not displayed in this case.
SHORTCUT 4	Any Parameter of the AUDIO SETTINGS and DISPLAY SETTINGS menus or None	If SHORTCUT 4 is not defined, Parameter value for SHORTCUT 4 is set to 'None'. SHORTCUT 5 and 6 are not displayed in this case.
SHORTCUT 5	Any Parameter of the AUDIO SETTINGS and DISPLAY SETTINGS menus or None	If SHORTCUT 5 is not defined, Parameter value for SHORTCUT 5 is set to 'None'. SHORTCUT 6 is not displayed in this case.
SHORTCUT 6	Any Parameter of the AUDIO SETTINGS and DISPLAY SETTINGS menus or None	If SHORTCUT 6 is not defined, Parameter value for SHORTCUT 6 is set to 'None'.

Details of SHORTCUTS menu Parameters

4.3.1.4 FACTORY SETTINGS

M1 SETUP >> FACTORY SETTINGS

FIRMWARE VERSION	1.0
UPDATE FIRMWARE	Update
RESET ALL SETTINGS	Reset
SHORTCUTS	Default mapping
NETWORK KNOWLEDGE	Clear
SERIAL NUMBER	14050101

The M1.1 SETUP >> FACTORY SETTINGS menu allows to get information about the current M1.1 firmware version, to update the M1.1 firmware and to reset the unit to its default configuration (or subset of settings).

Accessible Parameters are:

- FIRMWARE VERSION: Current firmware version (read only)
- UPDATE FIRMWARE: Allows to update the unit's firmware
- RESET ALL SETTINGS: Returns the unit to factory settings
- SERIAL NUMBER: Displays the serial number of the machine
- SHORTCUTS: Redefines all Shortcuts to factory default
- PROTECTION: Allows to bypass amplifier's protections
- NETWORK KNOWLEDGE: Clears list of detected devices on network

The following table details the Parameters of the FACTORY SETTINGS menu:

PARAMETER	RELATED ACTION/VALUE	REMARKS
FIRMWARE VERSION	<i>Firmware version</i>	<i>Firmware version</i> indicates the version of the current firmware. Format is <i>x.y</i> . This parameter is read only.
UPDATE FIRMWARE	Update	Selecting 'Update' launches the M1.1 firmware update process. A USB flash disc drive with a valid set of firmware must be inserted in the A-shaped USB port
RESET ALL SETTINGS	Reset	Selecting 'Reset' returns the M1.1 to its factory settings. Factory settings are detailed in the Specifications section.
SERIAL NUMBER	<i>Serial number</i>	<i>Serial number</i> indicates the serial number of the M1.1. Format is <i>yymm05nn</i> . This parameter is read only.
SHORTCUTS	Default mapping	Selecting 'Default Mapping' returns the M1.1's Shortcuts to their factory settings. Factory settings are detailed in the Specifications section.
PROTECTION	Disabled Enabled	Output short-circuit, output-DC, over-heat and amplifier-fault detection circuitry protect both the amplifier and the connected loudspeakers. In some regions of the world, the power distribution grid can be so polluted that spurious power grid noise can trig false error, thus muting or powering down the amplifier. In such extreme cases, and if it is of major importance that the M1.1 runs uninterrupted, protections can be temporary disabled by the end user, at his own risk.
NETWORK KNOWLEDGE	Reset	Clears the M1.1's memory of other CH Precision devices it has discovered through the TCP/UDP proprietary protocol.

Details of FACTORY SETTINGS menu Parameters



4.3.1.5 INSTALLED OPTIONS

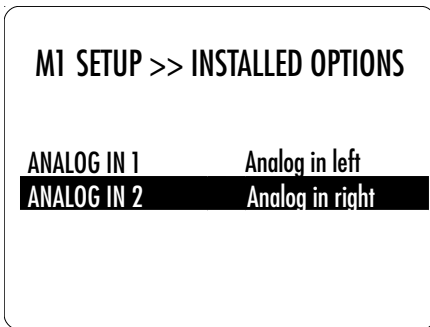

The M1.1 SETUP >> INSTALLED BOARDS menu provides read-only information about installed back panel boards. Details are:

- ANALOG IN 1: Input board installed in Slot 1
- ANALOG IN 2: Input board installed in Slot 2

The following table details the Parameters of the INSTALLED BOARD menu:

PARAMETER	PARAMETER VALUES	REMARKS
ANALOG IN 1, 2	Analog in Left, Analog in Right, -	Parameters are Read Only

Details of INSTALLED OPTIONS menu Parameters

4.3.1.6 NETWORK

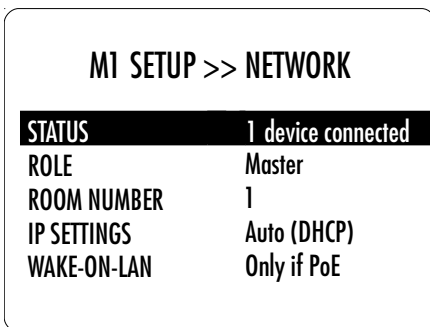

The M1.1 SETUP >> NETWORK menu display the information and allows the customization of the network related Parameters of the unit. Accessible Parameters are:

- STATUS: Listing of all CH products detected (product type, IP and MAC addresses)
- ROLE: Defines how the M1.1 interacts with other devices on the network
- ROOM NUMBER: Group units connected to a single network by room
- IP SETTINGS: Low-level network configuration
- WAKE-ON-LAN: Select if the unit can be powered on from the network

The following table details the Parameters of the NETWORK menu:

PARAMETER	PARAMETER VALUES	REMARKS
STATUS	IP address Product type MAC address	List of CH Precision devices and Android remote controls detected by the M1.1 (product type, IP and MAC addresses) Read Only parameters
ROLE	Offline Power master Master	When physically connected to a network, the M1.1 can ignore this network (offline) or connect to it as being the master or as a slave.



	Slave Custom	This networking facility allows information sharing among CH products.
ROOM NUMBER	1 ... 7	Define the room in which room the M1.1 is (multiroom applications). This prevents CH Precision units connected to the same network but located in different systems/rooms to interact with each others.
IP SETTINGS	Auto (DHCP) Direct-Link Manual	Auto should be selected if the M1.1 is connected to a router with DHCP server feature.
WAKE-ON-LAN	No Only if PoE Yes	If No is selected, the M1.1 can't be woken up by the app. Standby mode will consume less than 0.5W. When Only if PoE is selected, the M1 can only be waken by the app if connected to a Power-over-Ethernet switch. Standby mode will draw less than 0.5W from the mains plug. If Yes is selected, the M1.1 can always be woken up by the app. Standby mode will draw a couple of watts from the mains plug.

Details of NETWORK menu Parameters

4.4 Returning to factory defaults

The unit can be reset to the Factory default settings by using the RESET ALL SETTINGS item from the FACTORY SETTINGS menu. For a list of Factory default settings, please refer to the Specifications section.



5 Firmware update

5.1 Preparing the USB stick

The firmware of all the CH Precision units can be updated using the USB port located at the back of the unit. Before starting the firmware update, it is necessary to load a USB stick with files containing the new firmware. Use the FAT32 formatted USB 2.0 stick provided with you M1.1 . Please note that some USB sticks might not be detected by the M1.1 USB port. CH Precision recommends the use of Sandisk USB 2.0 sticks such as the one delivered with the unit.

The following procedure describes how to load the USB stick with the correct files:

1. Download the latest M1.1 firmware file from www.ch-precision.com
2. Decompress the .zip file and copy the decompressed files to the root of your USB stick. After doing so, your USB stick should contain the following files:
 - M1_xxx.dsl
 - M1_xxx.mcl
 - M1_xxx.ol1

where 'xxx' indicates the firmware revision.

Make sure all these files are present at the root of your USB stick, and that only one version of these files is present. Any missing file will make the firmware update procedure fail, while multiple versions of the same unit's firmware can lead to unstable M1.1 behavior after update.

5.2 Updating the unit's firmware

1. Perform the operations described in section 5.1
2. Connect the USB stick to the USB port located at the back of your M1.1 unit
3. Navigate to the FACTORY SETTINGS menu (see section 4) and select the UPDATE FIRMWARE item
4. Start the Firmware Update process by pushing the encoder button. Please note that the unit will perform a Reset (the display briefly turns off and on) during the procedure
5. Once the firmware update is complete, the unit automatically goes into Standby mode. Remove the USB stick and turn the unit on. The new firmware is now active. To verify that the firmware update is effective, navigate to the FACTORY SETTINGS menu and select the FIRMWARE VERSION item. The displayed firmware revision should match the firmware revision on the files copied to the USB stick



Note: The firmware update process lasts 5-10 minutes, **do NOT interrupt it!**

When performing a firmware update, do NOT press or turn any of the unit's front panel button/encoder, do NOT unplug the unit from the AC wall socket and do NOT turn the mains power switch off. Interruption of the firmware update procedure may result in corrupted firmware and a malfunctioning unit. In case something went wrong during a firmware update and the unit is malfunctioning, apply the emergency firmware update procedure described in the next section.

5.3 Emergency firmware update procedure

Perform the following Emergency Firmware Update procedure if your unit doesn't power up normally.

1. Perform the operations described in section 5.1
2. Power the unit off (back panel mains power switch to OFF)
3. Push and keep the standby/mute button pushed and power up the unit (back panel mains power switch to ON). Keep the standby/mute button pushed for a couple more seconds after you turned the unit on.
4. The unit performs the emergency firmware update. Once the operation is complete, the unit automatically goes into Standby mode. Remove the USB stick and turn the unit on. The new firmware is now active. To verify that the firmware update is effective, navigate to the FACTORY SETTINGS menu and select the FIRMWARE VERSION item. The displayed firmware revision should match the firmware revision on the files copied to the USB stick
5. If the emergency firmware update procedure fails, try the same procedure again using a different USB stick. If the failure persists, turn off your unit and contact your authorized dealer for assistance.

Note: The emergency firmware update procedure lasts 5-10 minutes, **do NOT interrupt it!**



6 Troubleshooting

Error	Action
No power	Check both AC power cords Check the power switch at the back of the unit Check the mains fuses on the AC power cord receptacle Check all 3 fuses and replace if necessary (High power: T1 6A for 230V mains and T32A for 100V and 115V mains; Small signal: T1 .6A for 230V mains and T3.1 5A for 100V and 115V mains; Standby: T250mA for 230V mains and T500mA for 100V and 115V mains)
No sound (general)	Check that your source is playing Check that your M1.1 is turned on and that the loudspeakers are properly connected Check that the system volume setting is not too low Check that the correct input is selected on your D/A controller or preamplifier Check that the correct input is selected on your M1.1 amplifier Check that the correct amplifier mode is engaged
No sound ("⊗" is displayed)	Your M1.1 is muted (display area 3 ⊗ must be off for the unit to output signal). Unmute the unit using the top front panel push button
Lost in the settings?	Restore factory setting and start your setup again
Software update fails	Try Emergency Software Update procedure If it fails, download the latest M1.1 firmware from www.ch-precision.com , prepare a software update image on a FAT32 formatted USB stick and follow the Emergency Software Update procedure again
USB flash drive for firmware update is not detected by M1.1	Please try another brand of USB flash drive (e.g. Sandisk).

Troubleshooting

If the error cannot be corrected using the information from the above table, disconnect the unit from the AC wall socket and from the rest of your system and contact your authorized dealer for assistance.



7 Specifications

Output power	
Bi-amplification mode	2 x 200W _{RMS} / 8Ω, 2 x 350W _{RMS} / 4Ω, 2 x 600W _{RMS} / 2Ω
Monaural mode	1 x 350W _{RMS} / 4Ω, 1 x 600W _{RMS} / 2Ω, 1 x 1100W _{RMS} / 1Ω
Bridge mode	1 x 700W _{RMS} / 8Ω, 1 x 1200W _{RMS} / 4Ω, 1 x 1600W _{RMS} / 2Ω
Analog inputs	
Single-ended	1 x RCA + 1 x BNC (Z _{in} = 47kΩ or 300Ω)
Balanced	1 x XLR (Z _{in} = 94kΩ; pin1 = GND, pin2 = +, pin3 = -)
Amplification	
Input stage	Ultra low noise, high slew rate, zero global feedback, full discrete class A design
Output stage	Ultra low noise, high slew rate, with adjustable feedback, full discrete class AB design
Feedback	Unique user programmable amplifier stage local/global feedback ratio in 10% steps
Gain	24 dB range adjustable gain in 0.5 dB steps
Analog Audio outputs	
Speaker terminals	2 pairs of customized Argento Audio binding posts
THD+Noise	Less than 0.01% (1kHz signal, BW 20Hz-20kHz, 10W _{RMS} under 8Ω, all operating modes) with 100% global feedback
SNR (A)	Better than 115dB (Monaural and Bi-amplification Modes), better than 118dB (Bridge Mode)
Bandwidth	DC to 450kHz (-3dB) at 1W _{RMS}
General	
Display	480 x 272 24bits RGB
Power supply	Selectable 100V, 115V or 230V AC, 47Hz to 63Hz, <1W in Standby
Dimensions (W x D x H)	440mm x 440mm x 265mm
Weight	75kg
Software update	USB port for software update / Ethernet based system control

Design and Specifications are subject to change without notice. Weight and dimensions are approximate

Illustrations are informative only and may differ from the actual production model

Enclosure designed by Mana Ishoni

FCC-Notice

Note: This equipment has been tested and found to comply with the limits for a Class B digital device, pursuant to Part 15 of the FCC Rules. These limits are designed to provide reasonable protection against harmful interference in a residential installation. This equipment generates, uses and can radiate radio frequency energy and, if not installed and used in accordance with the instructions, may cause harmful interference to radio communications. However there is no guarantee that interference will not occur in a particular installation.

If this equipment does cause harmful interference to radio or television reception, which can be determined by turning the equipment off and on, the user is encouraged to try to correct the interference by one or more of the following measures:

- adjust or relocate the receiving antenna
- increase the separation between the equipment and the receiver
- connect the equipment into a mains outlet on a circuit different from that to which the receiver is connected
- consult the dealer or an experienced radio/TV technician for help

Disposal – Environmental care

Directive 2002/96/EG of the European Parliament requires consumer electro-technical appliances to be disposed separately and have to be indicated with the following symbol. Should you dispose this component please do so in conformity with local and global legal and environmental regulations and according to best practices. We strongly encourage you to recycle any batteries used with this component.

